

SR23-3061-3

Courses:

41241

51241

54221



**Field Engineering Education
Student Self-Study Course**

**System/360
Introduction to I/O Operations**

PREFACE

This publication is primarily intended for use by IBM personnel enrolled in courses 41241, 51241, and 54221.

IBM is grateful to the American National Standards Institute (ANSI) for permission to reprint its definitions from the American National Standard Vocabulary for Information Processing, which was prepared by Subcommittee X3K5 on Terminology and Glossary of American National Standards Committee X3.

ANSI definitions are preceded by an asterisk. The symbol '(SCI)' at the beginning of a definition indicates that it has been discussed and agreed upon at meetings of the International Organization for Standardization Technical Committee 97/Subcommittee 1, and has also been approved by ANSI and included in the American National Standard Vocabulary for Information Processing.

Those wishing to reprint the asterisked ANSI definitions are advised to seek permission from the American National Standards Institute.

ANSI definitions appear in this course only when called from the glossary by the student using the "go to define" feature.

ZR25-5681-0

Fourth Edition (October 1973)

This is a major revision of SR23-3061-2 and makes all previous editions obsolete.

Issued to: _____
Branch Office: _____ No: _____
Address: _____

If this manual is mislaid, please return it to the above address.

Address any comments concerning the contents of this publication to:
IBM, Media Center, Dept 929, Rochester, Minnesota 55901.

CONTENTS

General Information	iv
Legend	iv
Course Description	iv
Instructions to the Student	vi
DATA CODING	1
SYSTEM/360 CHANNEL CONCEPTS	11
System/360 Channel Organization	13
System/360 Channels	24
Device Status Byte	32
INTRODUCTION TO I/O	
INTERFACE	39
Standard Interface	41
Interface Sequences	52
Interface Operation - Selector	
Channel	60
Interface Operation - Multiplexer	
Channel	68
Control Unit Busy Sequence	75
Initial Selection Status Bytes	79

GENERAL INFORMATION

LEGEND

ALU	Arithmetic and Logic Unit - a section of the CPU
CCW	Channel Command Word
CE	Channel End
CPU	Central Processing Unit
CSW	Channel Status Word
DE	Device End
EBCDIC	Extended Binary Coded Decimal Interchange Code
HEX	Hexadecimal; a numbering system using a base of 16
I/O	Input/Output
MPX	Multiplexor
OEMI	Original Equipment Manufacturers' Information
P bit	Parity bit
SIO	Abbreviation for "Start I/O"
SRL	System Reference Library

COURSE DESCRIPTION

This self-study text consists of three main sections which introduce the student to the data coding, channel concepts and I/O interface used with System/360.

The final quiz for this course tests the student on the objectives which are listed later in this description.

The sections of the course have these average completion times.

DATA CODING	.8 Hours
CHANNEL CONCEPTS	2.2 Hours
INTRODUCTION TO I/O INTERFACE	4.7 Hours
FINAL QUIZ	<u>.8 Hours</u>
Total Average Time	8.5 Hours

Prerequisites

Course 41207 - Introduction to Computers or prior training on 1400-7000 series DPS

Objectives

When you complete this course, you should be able to meet these objectives using the documentation listed. The final quiz will test you on these and only these objectives.

Documentation:

System/360 Reference Data Card	GX20-1703
System/360 I/O Interface OEMI	GA22-6974

1. Given the hexadecimal notation for any byte, write the binary bit structure. Given the binary bit structure of a byte, express it in hexadecimal notation.
2. Given any valid hole punching in an IBM card, express its corresponding EBCDIC bit structure using hexadecimal notation. Given any byte, indicate its corresponding card code hole punching.
3. Given an unlabelled architectural diagram of a System/360, identify the elements as to:
 - a. Main Storage
 - b. Central Processing Unit
 - c. Channel
 - d. Input or Output Device
4. Given a channel command word written in hexadecimal notation, specify the:
 - a. Command operation to be performed
 - b. Numbers of bytes to be transferred
 - c. Storage addresses of the data
5. Name the sequences on the I/O interface and the function of each.
6. Explain the difference between burst mode and multiplex mode with respect to:
 - a. The number of concurrent operations being performed by the channel
 - b. The selection of the I/O device.
7. Identify the bits in the I/O device status byte and explain the meaning of the following bits:
 - a. Channel End
 - b. Device End
 - c. Unit Check
 - d. Unit Exception
8. Describe the function of the following bytes:
 - a. Data
 - b. Status
 - c. Sense
9. Given the timing charts in the I/O interface OEMI (GA22-6974), explain the significance of tag lines as they occur for the following sequences.
 - a. Initial Selection
 - b. Data Handling
 - c. End Sequence
 - d. Control Unit Busy
10. Describe the result of a non-zero status byte during Initial Selection

MATERIALS REQUIRED

Your course administrator or monitor will provide you with materials necessary to complete this course.

INSTRUCTIONS TO THE STUDENT

This is a "self-study" text. The material is presented in logical steps called "frame" Each frame presents material to which you will be required to make a response. Each frame will be terminated with a horizontal line. The answer or answers to a frame will be found in the left margin of the next frame.

You should make an attempt to respond to each frame without looking at the answer. A blank card is ideal for this purpose. Slide it down the page until you uncover a horizontal line. Read the material in the frame and make your response. It is not necessary to write your response to each frame. Just "thinking" of the correct answer is sufficient.

Although some frames may be more difficult than others, you should be able to respond with a minimum of difficulty. Each major topic in this book is called a session at the end of which you will find self-evaluation questions. These questions measure you on the objectives for that session. You should contact your course administrator for assistance only if you have difficulty with these questions.

At this time, turn to the back of this book and notice the Time/Page Log. This is to help you keep track of your place in the text so you won't have to do unnecessary re-reading. At the end of each study period you should record the amount of time you required and the page at which you left off.

The back of this publication contains an alphabetic index of all topics covered in this text. You should use it for reference purposes.

System/360 Data Coding

CONTENTS

	<u>Page</u>	<u>Average Study Time</u>
SYSTEM/360 DATA CODING	3	45 Minutes
Hexadecimal Notation	4	
Converting Binary to Decimal	6	
EBCDIC	7	
Parity	8	
Self-Evaluation Questions	9	

System/360 Data Coding

The basic unit of data in the System/360 is eight bits long and is called a byte. The bit positions of a byte are numbered 0-7 from left to right.

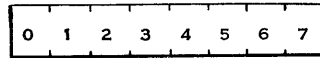

THE BYTE

The System/360 uses the byte to represent one of the following:

1. an alphameric character
2. two binary-coded decimal digits
3. an eight bit binary number
4. eight bits of control information
5. part of a larger field of information such as an instruction or an I/O control word.

In this course you will see the byte used for many of the above purposes such as a data byte representing an alphameric character or as control information representing the address of an I/O device.

One byte \longrightarrow 10110111

Rather than writing out all the binary digits of a byte, it is usually desirable to express them with some sort of shorthand notation. Hexadecimal notation is the shorthand method used in most System/360 documentation to represent bytes of information. In our first topic, you will learn how to use this hexadecimal notation.

HEXADECIMAL NOTATION

You should know that a byte of data can be used to represent:

- a. A binary number consisting of _____ bits.
- b. A _____ digit decimal number.
- c. One _____ character

Which of these are represented by a byte will depend on the particular computer being used. Some computers can process all types of data. In this case, the interpretation will depend on the instruction being executed at the time. System/360 can handle all types of data.

eight
two
alphanumeric

To avoid confusion as to the meaning of a byte, the actual bits can be shown using a shorthand notation. The bits are divided into two groups of four bits each. The bit combinations of 0000 - 1001 are represented by the decimal digits: 0-9. Bit combinations of 1010 - 1111 are represented by the letters A-F respectively.

<u>Binary</u>	=	<u>Hex</u>
0000	=	0
↓		↓
1001	=	9
1010	=	A
1011	=	B
1100	=	C
1101	=	D
1110	=	E
1111	=	F

For example, the following byte would be represented as 2F.

0010 1111

The following byte would be represented as _____.

1111 1111

FF

This method of representing the bits of a byte is called hexadecimal notation or hex notation for short.

The following byte would be represented as 7A in _____.

0111 1010

hex notation

In hex notation, the following byte would be shown as _____.

0101 1010

Hint:

0000-1001 = 0-9

1010-1111 = A-F

5A

Which of the following is a byte? Express its bit content in hexadecimal notation.

- a. 1001 _____
- b. 100100 _____
- c. 10011101 _____
- d. 011111001111 _____

c. 9D

Complete the hex notation or binary coding of the following:

	<u>Binary</u>	<u>Hex Notation</u>
a.	00001111	_____
b.	_____	7A
c.	_____	EC
d.	10110110	_____

- a. 0F
- b. 01111010
- c. 11101100
- d. B6

To summarize, a byte is eight bits long and is usually documented as two hexadecimal digits. Each hexadecimal digit represents four bits. Bits of 0000 through 1001 are represented as 0 through 9, and bits of 1010 through 1111 are represented as A through F.

CONVERTING BINARY TO DECIMAL

Occasionally it is necessary to convert a binary number to a decimal number and vice versa. If the binary number is only one byte long, there is no great problem. Simply add the place value (128, 64, 32, etc.) wherever a 1 bit is present. However, when the binary number consists of several bytes, the problem of conversion would be quite boring. Fortunately there are conversion charts which can be used to convert between binary and decimal. Your System/360 Reference Data Card contains such a chart, labeled "Hexadecimal and Decimal Conversion." Binary numbers are usually expressed in hexadecimal notation. To convert, find the decimal equivalent for each hex digit and add the total.

For instance, a three byte binary number expressed as F01AEB would be converted by adding the following decimal numbers from the chart.

15,728,640	←	F
00 000 000	←	0
4,096	←	1
2,560	←	A
224	←	E
11	←	B
<hr/>		
15,735,531		

Using the chart on your Reference Data Card, convert the following binary numbers, expressed in hex, to decimal numbers.

a. FE

b. DA96

EBCDIC

a. FE ← 14
 ↑ 240
 254

The System /360 has a card code whereby each possible bit combination of a byte can be punched in one column of an IBM card. This code is called EBCDIC (Extended Binary Coded Decimal Interchange Code). With this code, a card column can be used to represent (just like a byte):

b. DA96 6
 144
 2560
 53248
 55958

- a. An eight-bit binary number.
- b. Two binary-coded decimal digits.
- c. One alphameric character.

Take a look at the pages in the rear of your System/360 Reference Data Card (X20-1703). Along the right side of these pages are two columns labelled "Punched Card Code" and "System /360 8-Bit Code." With these two columns, you can determine what hole punching is needed to produce any given 8-bit combination. Notice that the 8-bit code column is arranged in order of ascending value.

To produce a bit combination of 00000000 would require hole punches of 12, 0, 9, 8, 1. The hex notation for the 8-bit code is shown on the left side of the pages.

Use Reference Data Card for this one. Show, using hex notation, how the following IBM card hole punches would be represented in an EBCDIC byte.

<u>Byte</u>	<u>Hole Punches</u>
a. _____	None (blank column) -
b. _____	12, 1
c. _____	0
d. _____	12, 11, 0, 9, 8, 7

- a. 40
- b. C1
- c. F0
- d. FF

Use Reference Data Card for this one. Indicate the hole punches necessary to represent these bytes (expressed in hex notation) in an IBM card.

<u>Byte</u>	<u>Hole Punches</u>
a. 00	_____
b. 40	_____
c. A7	_____
d. C6	_____
e. F4	_____

PARITY

- a. 12, 0, 9, 8, 1
- b. no punches
- c. 11, 0, 7
- d. 12, 6
- e. 4

Most systems use some form of parity checking. That is, they require each unit of data to contain either an even number or an odd number of 1 bits.

System /360 uses the byte as its basic unit of data and requires odd parity. That is, each System /360 byte must contain an odd number of 1 bits or a machine error will be detected.

For this reason, each byte contains a ninth bit, called the P (or parity) bit.

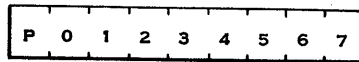

THE BYTE

As can be seen above, the left most bit of a byte is the parity bit.

The data bit positions are numbered 0-7 from left to right. Although each byte contains a parity bit, the byte is usually shown as two hex digits and it's up to you to determine whether the parity bit should be 0 or 1.

Indicate the P bits for the following bytes.

	<u>P Bit</u>	<u>Data Bits</u>	<u>Hex Notation</u>
a.	_____	10010001	91
b.	_____	00010001	11
c.	_____	01110000	70
d.	_____	00000000	00
e.	_____	11111111	FF

-
- a. 0
 - b. 1
 - c. 0
 - d. 1
 - e. 1

You should now be able to:

1. Express a byte in hex notation.
 2. State its equivalent card code.
 3. Determine the status of its parity bit.
 4. Obtain its decimal value using your Reference Data Card.
-

SELF-EVALUATION QUESTIONS

The Reference Data Card should be used to answer these questions.

1. A byte contains _____ data bits plus a parity bit.
2. Given the following bytes, represent them in hex notation.

	<u>Byte</u>	<u>Hex Notation</u>
a.	0001 0010	_____
b.	1111 0001	_____
c.	1010 1100	_____

3. Given the following EBCDIC alphameric characters, indicate their bit structure (in hex) and the hole punches needed to represent them in an IBM card.

	<u>Graphic</u>	<u>8-Bit Code (In Hex)</u>	<u>Hole Punches</u>
a.	A	_____	_____
b.	F	_____	_____
c.	Q	_____	_____
d.	X	_____	_____
e.	7	_____	_____
f.	*	_____	_____
g.	#	_____	_____
h.	Blank (SP)	_____	_____

4. Given the following System/360 bytes, in hex notation, indicate whether the P bit would be a 1 or a 0.
 - a. F0 _____ (0/1)
 - b. A6 _____ (0/1)
 - c. C7 _____ (0/1)
 - d. 5E _____ (0/1)
5. Convert the following binary number (expressed in hex) to a decimal number using your Reference Data Card.

<u>Binary</u>	<u>Decimal</u>
0A11FF	_____

ANSWERS

1. eight

2. a. 12 bits 0000-1001 = 0-9
 b. F1 bits 1010-1111 = A-F
 c. AC

		<u>8 bit code</u>	<u>Card code</u>	
3.	a.	A	C1	12, 1
	b.	F	C6	12, 6
	c.	Q	D8	11, 8
	d.	X	E7	0, 7
	e.	7	F7	7
	f.	*	5C	11, 8, 4
	g.	#	7B	8, 3
	h.	Blank	40	no punches

4. a. 1
 b. 1
 c. 0
 d. 0

5. 659,967

0A11FF ← 15
 240
 256
 4096
 655360
 000000
 659967

System/360 Channel Concepts

CONTENTS

	<u>Page</u>	<u>Average Study Time</u>
SYSTEM/360 CHANNEL ORGANIZATION	13	60 Minutes
Channel Commands	14	
Overview of Channel Operation	17	
Self-Evaluation Questions	22	
SYSTEM/360 CHANNELS	24	35 Minutes
Selector Channels	24	
Multiplexor Channels	26	
Self-Evaluation Questions	30	
DEVICE STATUS BYTE	32	40 Minutes
Self-Evaluation Questions	36	

System/360 Channel Organization

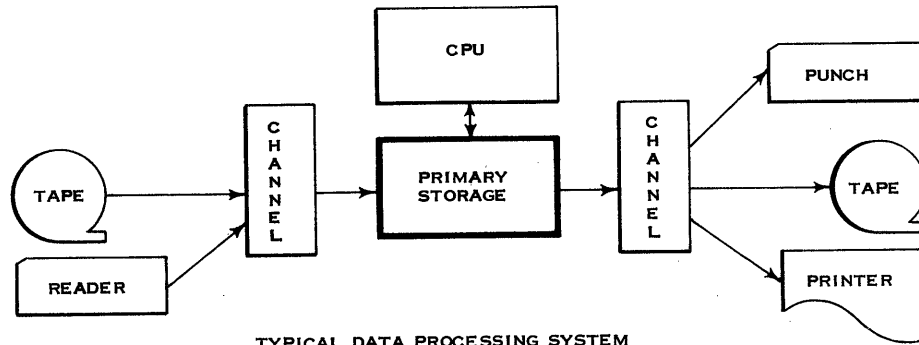

TYPICAL DATA PROCESSING SYSTEM

The preceding figure shows a typical data processing system, such as System /360. Data processing consists of three steps: Input, Processing, and Output. The elements of the system which perform these steps are:

1. CPU or Central Processing Unit. This unit executes the instructions of the stored program one at a time and processes the data.
2. Primary storage or main storage. This unit holds the stored program as well as the data to be processed. This text will use the term "Main Storage".
3. The input and output devices such as card readers, card punches, printers, and magnetic tape units. The CPU can only process data which is in main storage. As a result, the I/O data flow is between the I/O devices and the main storage unit.

We did not mention another unit which was shown in the preceding figure. This unit is the channel. Since it is placed between the I/O devices and the main storage unit, you can guess it has something to do with input-output operations.

The main function of the channel is to handle the flow of data between the I/O device and main storage. This leaves the CPU free to continue executing instructions as it processes other data which is already in the main storage.

Before input data can be processed by the CPU, it must first reside in _____.

main storage

Before processed data can be sent to an output device, the CPU must place the data in _____.

main storage All data flow between I/O devices and the main storage passes through the _____.

channel The channel receives data from the I/O device one byte at a time. On output operations, it also transmits one _____ of data at a time to the I/O device.

byte One of the main functions of the channel is to request main storage cycles for the I/O devices. Although only one byte at a time flows between the channel and device, the amount of data between the channel and main storage can vary from one byte to as many as eight bytes on the larger models of System /360. For instance, during an output operation on a System /360 Model 50, the channel would obtain four bytes at a time from the main storage. The channel would then send them one byte at a time to the I/O device.

While this activity is going on, the CPU is also sharing the main storage unit as it executes the instructions which process data. We say that processing is "overlapped" with the I/O operation.

This simultaneous operation of the channel and the CPU with both having access to the _____ unit is called "overlap".

CHANNEL COMMANDS

main storage The CPU needs an instruction to tell it what to do as well as where the data is located.

In like manner, the channel also needs to know what to do and where to put or obtain data. The channel obtains this information from something called a "command." Just like instructions, the "commands" normally reside in _____.

main storage The illustration on the facing page shows three main areas of a System/360.

1. Main Storage. This unit has an area set aside for the special control words used in System/360. These control words have fixed storage locations. For this reason the area is referred to as Permanent Storage. Only the storage locations are permanent. The contents of the control words may be changed by the stored program the same as any other main storage location. The Permanent Storage area consists of the first 128 bytes of main storage.

Main Storage also contains the stored program, the Channel commands, and the data areas. These can be located anywhere in the main storage.

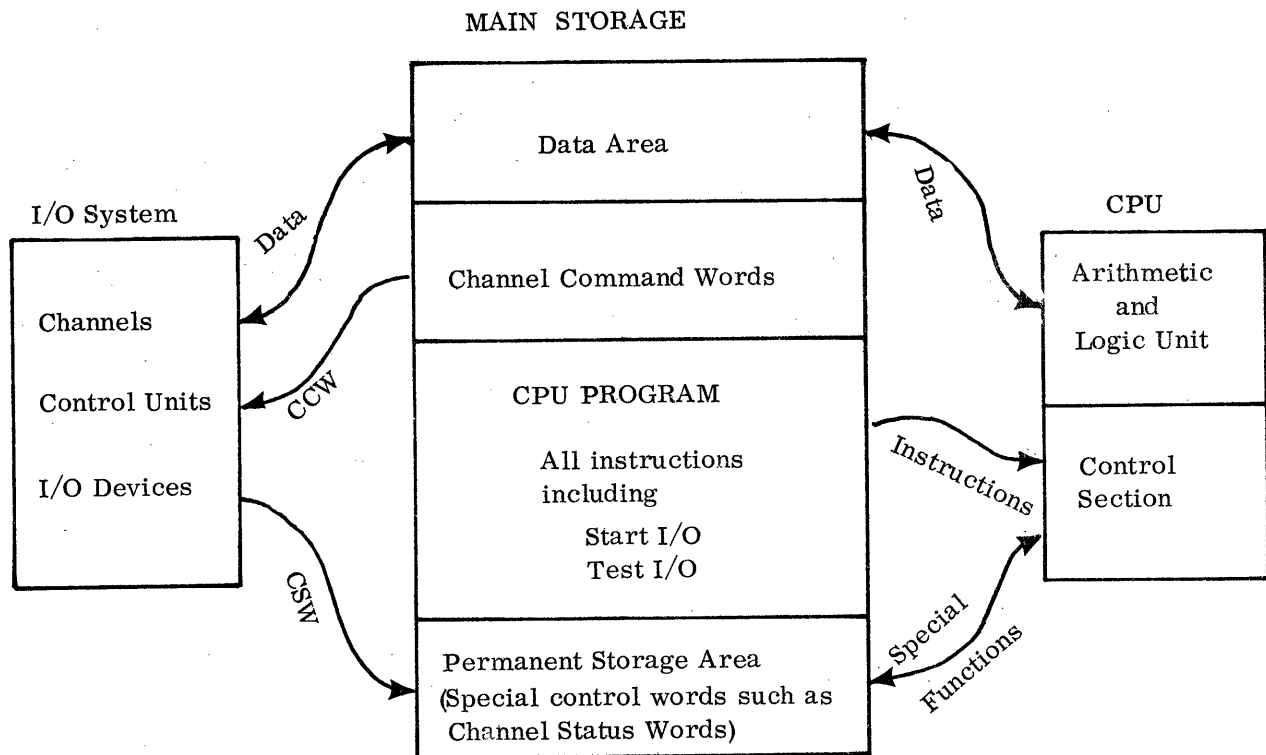

2. **CPU (Central Processing Unit).** This is the area which fetches and executes the instructions of the stored program (herein called the CPU Program). CPU has two sections:
 - a. The Control section which fetches and decodes the instructions and "controls" CPU operations. For special functions, it uses control words from the Permanent Storage area in main storage.
 - b. The Arithmetic and Logic Unit (ALU) which is used to process the data according to the instruction being executed. The control section tells ALU what to do with the data.

3. **I/O System.** This area consists of the channels, I/O control units, and I/O devices. Channel Commands (CCW's) are obtained from main storage and executed by the channel. The data from the I/O devices is read into the Data Area in Main Storage to be processed by the CPU. At the end of an I/O data transfer, status information concerning the data transfer is placed in a control word (CSW) which is stored in the Permanent Storage Area of Main Storage. The CPU program can examine this status information to check on the results of the I/O operation.

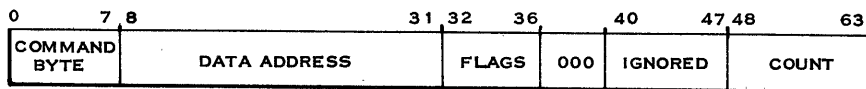

THE CHANNEL COMMAND WORD

A System /360 command is called a "channel command word" or CCW for short. It is eight bytes long and contains four fields:

1. A "command code" which tells the channel and I/O device what to do.
2. The "data address" which gives the location in main storage of the data field. That is, it tells where to get or put the data.
3. A "byte count" which specifies the length of the data field. That is, how many bytes are to be transferred between the I/O device and main storage.
4. A "flag" field which is used to expand on the command code. We will not be concerned with this field during this course.

The System /360 "channel command word" is eight bytes or 64 bits long. The bits are numbered 0-63 from left to right. Take a look at your Reference Data Card. It shows the format of the "channel command word."

As can be seen:

- a. The leftmost byte is the _____.
- b. The "data address" is _____ bytes long.
- c. The "byte count" is in the right most _____ bytes of the CCW.

command byte (code)
three
two

The following is a "channel command word" expressed in hex notation.

02 000800 0000 0050

- a. The "command code" is _____ (hex).
- b. The "data address" is _____ (hex).
- c. The "byte count" is _____ (hex) or _____ (decimal).

- a. 02
- b. 000800
- c. 0050 (hex)
80 (decimal)

Your Reference Data Card shows the command code meanings for some typical System /360 I/O devices. You will learn these more fully when you study the specific devices. For now, take a look at the command codes for the 2400 magnetic tape units as shown on the Reference Card. It shows that a command code of 02 specifies a read operation and a command code of _____ specifies a write operation.

01

Given the following channel command word, to be used with a 2400 magnetic tape unit, answer the questions.

CCW → 02 000800 0000 0050

- a. The channel and tape unit will perform an _____ (input/output) operation.
- b. The main storage address of the first data byte is _____ (in hex).
- c. A total of eighty data bytes will be transferred as shown by the byte count of hex _____.

- a. input
- b. 000800
- c. 0050

Suppose you wanted to write sixteen bytes on a 2400 magnetic tape unit. The data bytes begin at hex address 1000 in main storage. Complete the following "channel command word" to do this. The byte count is to be shown in hex. Look up 16 in the Decimal column of your Reference Card. The Hex column next to it will show the hex equivalent.

0 0 0 0

OVERVIEW OF CHANNEL OPERATION

01 001000 0000 0010

At this time, you should know that the function of the channel is to execute a "channel command word" as it handles the transfer of data between main storage and an I/O device. You have been introduced to the makeup of a typical System /360 "channel command word."

For now, let's take a quick look at an overall channel operation. Channel operations are initiated by an instruction in the CPU program. This instruction is appropriately called "Start I/O."

CPU INSTRUCTIONS

Instruction 1	Add	FIELDA, FIELDB
Instruction 2	Store	FIELD C, FIELD A
Instruction 3	Start I/O	2400 Magnetic Tape Unit
	Additional	
	CPU	
	Instructions	



After the data for one record has been processed, the CPU program will usually want to write the data on some output device. The channel will handle the data flow by executing a "channel _____ word". The CPU executes a _____ instruction which gets the channel started.

command
Start I/O

Use Figure 1 which faces page 22 for the rest of this topic.

Besides telling the channel to execute a channel command word, the Start I/O instruction in the CPU program also provides the address of the device.

An instruction has two parts: The operation code and the Address. In the case of a "Start I/O" instruction, the op code would tell the channel to execute a _____ while the address part would supply the address of the _____.

command
I/O device

Figure 1 shows four types of I/O devices which are connected to the channel by a common set of communication lines called the I/O interface. The interface lines are actually contained in a pair of cables which connect between the channel and the control units for the I/O devices. Each type of I/O device has its own control unit which synchronizes the device with the channel.

According to the figure, how many control units can be connected to a channel? _____

According to the figure, how many magnetic tape units can be connected to a tape control unit? _____

eight
eight

Notice that in the case of the 2540 Reader-Punch and the 1403 Printer, one 2821 control unit is used. However, this unit is an integrated control unit containing separate circuitry for each of the three devices: Reader, Punch, and Printer. In other words, it is three separate control units packaged as one. It can be connected to the standard I/O interface along with seven other control units.

As you would expect, the I/O interface is used to transfer data bytes to and from the channel.

In addition to the data bytes, _____ bytes can be sent to the I/O control units and _____ bytes can be sent to the channel (refer to figure 1). The meaning of these bytes will be explained in the following frames.

command
status

A command byte is nothing more than the "command code" from the channel command word. The channel retains and uses the entire command word. However, the command code information is sent to the I/O control unit which also needs to know what operation is to be performed.

Besides sending data bytes, the I/O device can also send status bytes to the channel. A status byte is nothing more than what its name implies. It indicates something concerning the status of the device.

Generally speaking, a status byte is sent at two times during an operation:

1. During the execution of the "Start I/O" instruction, the device sends an initial "status byte" which tells the channel and CPU program whether or not the operation was started and indicates why if it did not start.
2. At the end of the channel operation (when the data transfer is completed), the device sends an ending "status byte" which tells the channel (and subsequently the CPU program) if the data transfer was completed without error.

Name two types of bytes which can be sent by the channel to the I/O control unit.

- a. _____ bytes
- b. _____ bytes

command
data

Name two types of bytes which can be sent by the I/O control unit to the channel.

- a. _____ bytes
- b. _____ bytes

status
data

Match the following:

- | | | | |
|----------|---------------|----|---|
| a. _____ | Data bytes | 1. | Comes from the channel command word. |
| b. _____ | Status Bytes | 2. | This is the information read from or written on the I/O device. |
| c. _____ | Command Bytes | 3. | Indicates if the operation was started. |
| | | 4. | Indicates if the operation was completed without error. |

-
- a. 2
 - b. 3, 4
 - c. 1

With reference to figure 1, we have discussed everything between the channel and I/O devices. Continuing on, let's look at the other side of of the channel. As would be expected, the channel obtains its channel command words and the _____ (input/output) data bytes from _____.

output
main storage

On an input operation, we would expect the channel to store data bytes in main storage.

Looking at figure 1, we can see that the channel can also store channel _____ words.

status

Just what is a channel status word? Well, it is eight bytes long and contains a lot of good information. As might be expected, the _____ byte from the I/O device is part of the channel status word.

status

The channel status word is usually stored after the end of an operation. The CPU program can then examine it to see if the operation was okay. Page 11 of your System /360 Reference Data Card shows the makeup of the "channel status word." We are not concerned at this time with much of its contents. Notice, however, that its "status" portion is two bytes long (bits 32-47). The left most status byte is from the I/O device while the other byte reflects the status of the channel itself.

The following shows the sequence of a channel operation.

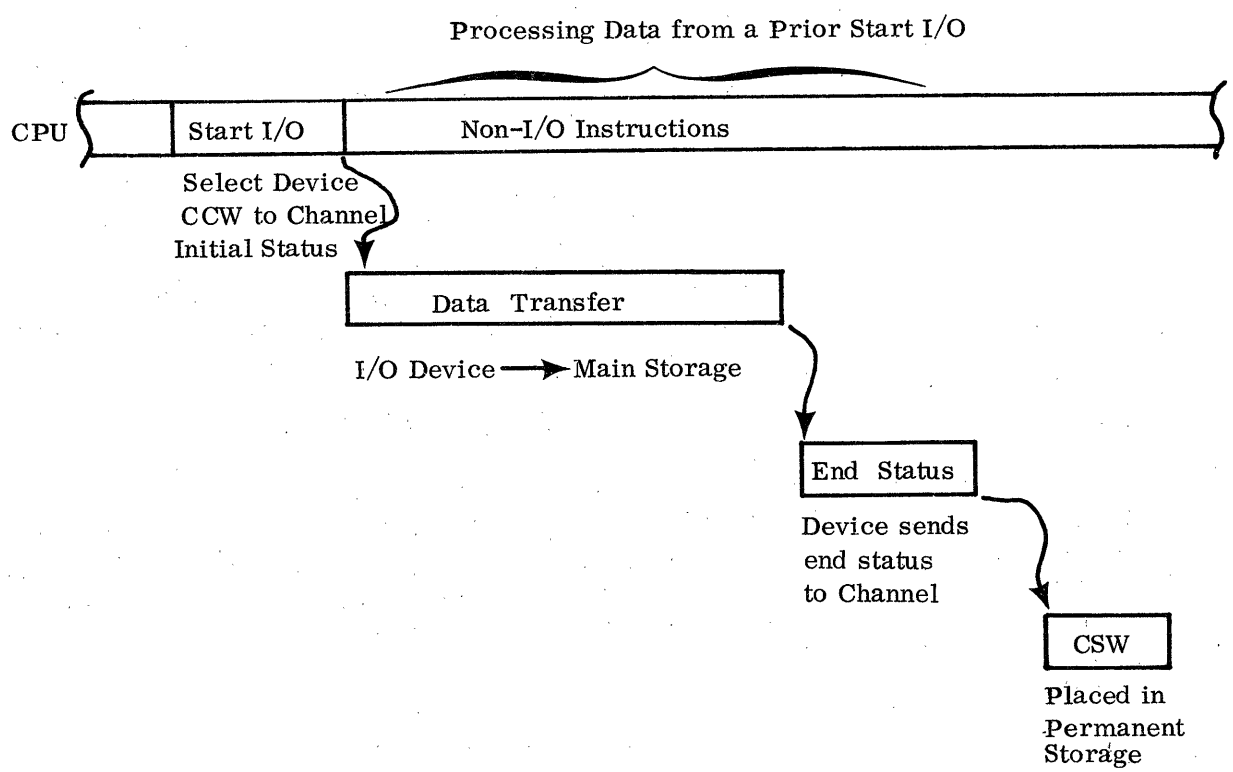

Still looking at figure 1, let's go through the steps of a channel operation.

Step 1: The CPU tells the channel to start an I/O operation on device X. CPU does this with a _____ instruction which contains the address of the _____.

Step 2: Channel obtains the command word. The command word resides in _____ and contains these fields.

- A one byte _____ code.
- A three byte _____.
- A flag field to expand on the operation (ignored for this course).
- A two byte _____.

Step 3: The Channel selects the I/O device, transmits the command byte to the control unit, and obtains the device's initial status byte.

This status byte indicates whether or not the device can perform the operation specified by the _____ byte.

Step 4: CPU disconnects while the channel handles the data transfer for the I/O device. Normally, the initial status byte is all 0 bits which indicates that the I/O operation was started. At this time, CPU ends its execution of the _____ instruction and proceeds to the next sequential _____.

Step 5: I/O device sends another status byte when the data transfer is completed. This status byte indicates the status of the device at the end of the channel operation. For one thing, it would indicate to the CPU program whether or not the data transfer was error-free.

Step 6: The channel stores its status as well as the device's status byte in the CSW for use by the CPU program. The status bytes are placed in main storage in what is called the channel _____ word.

-
- Step 1: Start I/O
I/O Device
- Step 2: Main Storage
- command
 - data address
 - _____
 - byte count
- Step 3: Command
- Step 4: Start I/O
instruction
- Step 5: _____
- Step 6: Status
-

SELF-EVALUATION QUESTIONS

1. All data flow between I/O devices and the main storage is controlled by and passes through the _____.
2. The channel receives _____ of data at a time from an I/O device.
3. The simultaneous operation of an I/O device on the channel and the processing of instructions in the CPU is known as _____.
4. The I/O device and control unit communicates with its channel via a _____ cable.
5. Name three fields in a System/360 channel command word.
 - a. _____
 - b. _____
 - c. _____
6. Which of the following occurs first when a Start I/O instruction is being executed?
 - a. Channel sends command byte to I/O device.
 - b. I/O device sends status byte to the channel.
7. What is the function of the status byte presented during Start I/O time?

8. The device status byte is also presented at other than Start I/O time. When does this happen and why?

9. Where is the device status byte placed so the CPU program can examine it?

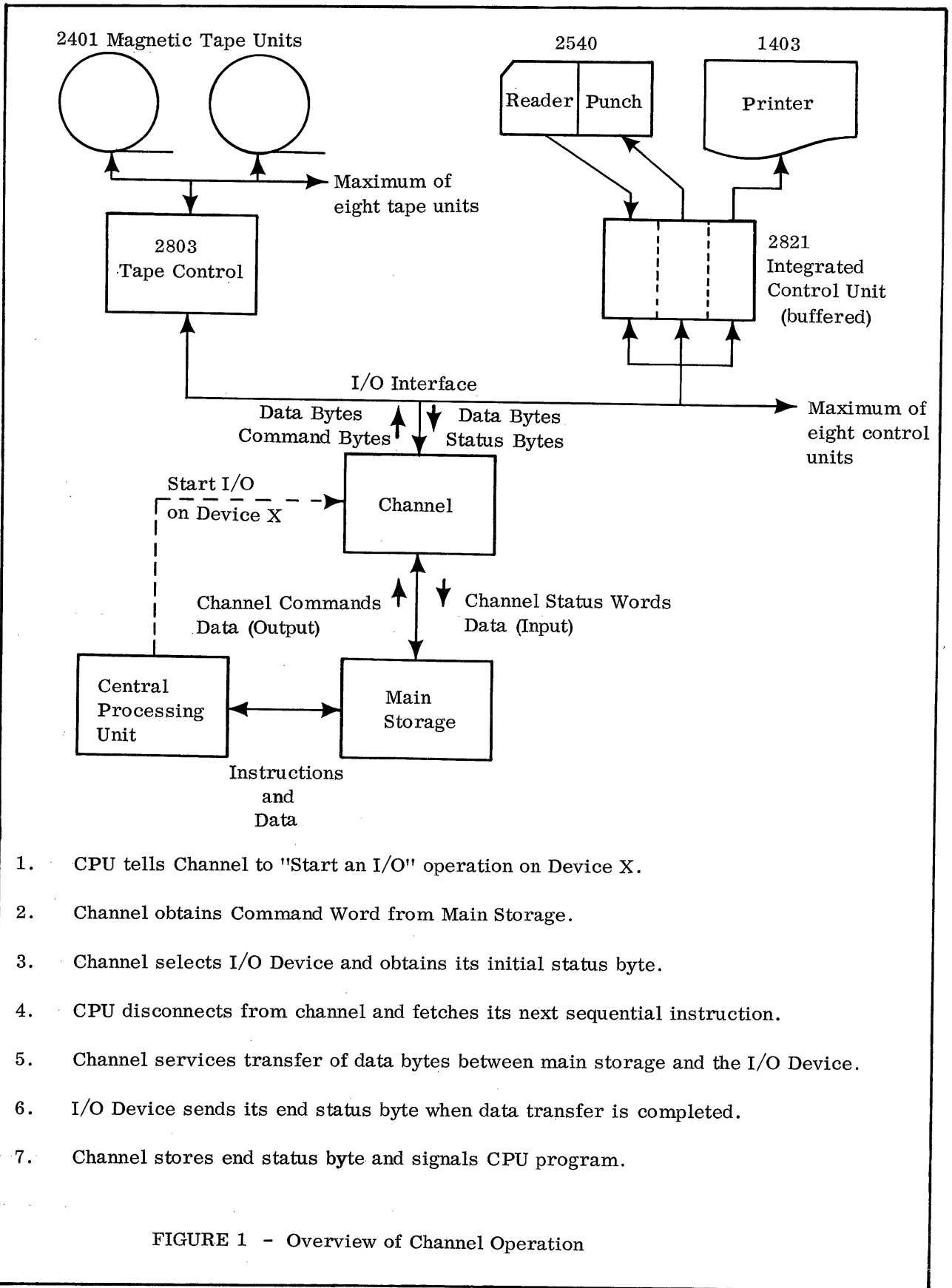

ANSWERS

1. channel
2. one byte
3. overlap
4. standard interface (I/O Interface)
5.
 - a. command code
 - b. data address
 - c. byte count
6. a
7. It is used to tell the CPU program whether or not the operation was started.
8. A status byte is also presented at the end of the data transfer. This byte is used to tell the CPU program whether or not the operation was performed correctly.
9. Any of these answers are acceptable:
 - a. in the Channel Status Word (CSW)
 - b. in Permanent Storage
 - c. in Main Storage

System/360 Channels

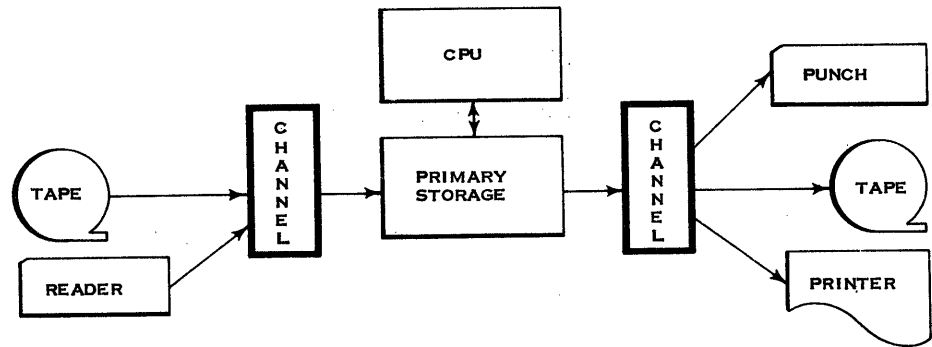

Channels are logical concepts in I/O operations. In the System/360, they may be stand-alone units as in the Model 75 or may be packaged along with main storage in the CPU housing as in the Model 30. In the lower models of the System/360, many of the processing units' circuits are used by the channels for their functions. There are two types of channels used by System/360: 1) selector channels, and 2) multiplexor channels. Let's discuss the selector channels first.

SELECTOR CHANNELS

Selector channels are available on all models of the System/360. The maximum number per model varies from two for a model 30 to six for a model 75. The selector channel is so named because only one I/O device can be selected on the channel at any one time. Once selected, a complete record is transferred over the standard I/O interface one byte at a time.

On a selector channel, only one I/O device can be _____ at a time. Once selected, a _____ is transferred over the standard _____ one byte at a time.

selected
complete record
interface

Once the record has been transferred, the channel is free to select another I/O device. When a channel is transferring an entire record between main storage and an I/O device, it is said to be operating in "Burst Mode." Since a selector channel always transfers an entire record, it can only operate in burst mode.

The operation of a channel with only one I/O device for the entire record is known as _____. Burst mode is the only mode in which a _____ channel can operate.

burst mode
selector

In summary then, on a selector channel, one I/O device transfers an entire record over the channel's standard interface. During this time no other I/O device can be using the channel. The other I/O devices could, however, be in the process of a feed cycle involving no data transfers over the channel. This is most apparent in those I/O devices which have buffers in their control units.

On a selector channel, one I/O device transfers an _____ over the channel. This mode of channel operation is known as _____. During this period of time no other I/O device can be using the _____.

entire record
burst mode
channel

Although only one I/O device can be operating on a selector channel, at any one time, more than one selector channel can be operating simultaneously. The following illustration shows an input record being read in from tape over selector channel 1 at the same time as an output record is being transferred over selector channel 2. All channels have their own individual standard interface cables.

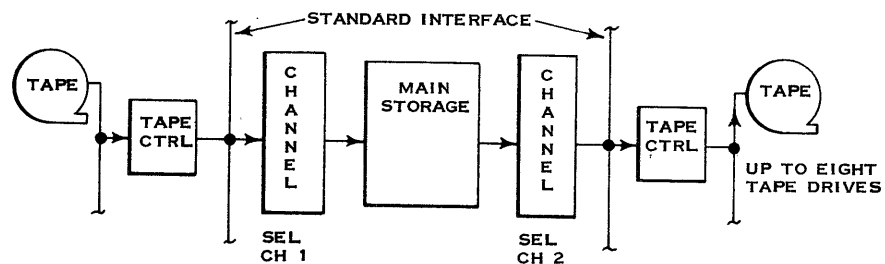

Each channel has its own _____ cables.

All channels can be in operation (your own words)

interface
simultaneously

Selector channels are designed to operate with high data rates. I/O devices such as magnetic tape, disk units, and drums are the devices most likely to operate on a selector channel. For operating with communication terminals in a real time application or with low data rate devices like an unbuffered card punch unit, a multiplexor channel is used.

I/O devices that operate at high data rates usually use _____ channels which can operate only in _____ mode.

For operation with low-speed or real-time I/O devices, a _____ channel is available on System/360.

MULTIPLEXOR CHANNELS

selector
burst
multiplexor

A Selector channel is designed to operate with only one I/O device at a time on an entire record basis. A Multiplexor channel is designed to operate with a number of I/O devices simultaneously on a byte basis. That is, several I/O devices can be transferring records over the multiplexor channel, time-sharing it on a byte basis.

A number of I/O devices can be operated simultaneously with a _____ channel. The I/O devices time-share the multiplexor channel on a _____ basis.

multiplexor
byte

This time-sharing mode of operation is known as "Multiplex" mode. Selector channels can only operate in _____ mode. Multiplexor channels can operate in _____ mode.

burst
multiplex

A comparison of burst versus multiplex mode can be seen below

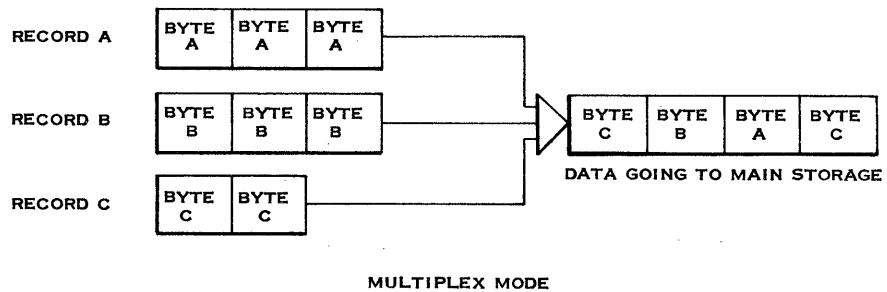
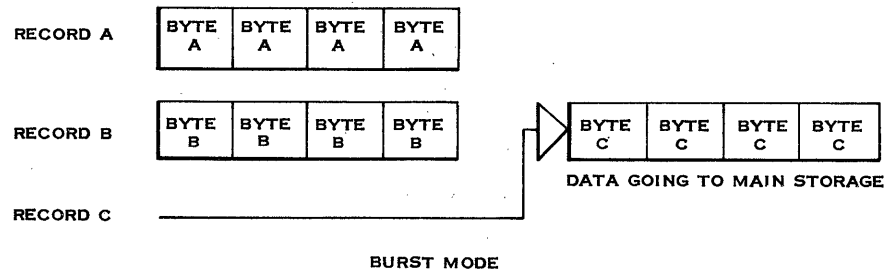

To handle data flow from an I/O device, the channel needs to know certain information such as:

1. In which direction does data flow (input versus output)?
2. Where in main storage should data be placed or taken out of?
3. How many bytes should be sent to an output device or accepted from an input device?

Information of this type is contained in the I/O command addressed to a particular I/O device. For a selector channel, which operates with only one I/O device at a time, the information may be placed in the channel registers and left there to control the operation.

Information necessary to control a selector channel operation is retained in the channel _____. This information was obtained from the I/O _____ addressed to a particular I/O device.

registers
command

On a multiplexor channel, it is possible to have many I/O devices operating simultaneously. The actual maximum number varies with the particular model and main storage of the System/360. In any case, it is not feasible to have this control information in the multiplexor channel's registers. A set of registers would be necessary for each I/O device! Instead, the multiplexor channel keeps this information in a special storage area. As a byte of data comes in from a particular I/O device, the multiplexor channel brings the necessary information out of the special storage area and places it in its registers. After the byte of data from the I/O device has been serviced, the information in the registers is automatically put back into the special storage area.

A number of I/O devices can operate on a _____ channel simultaneously. The control information necessary for each I/O device is kept in a special _____.

multiplexor
storage area

As a byte of data comes in from an I/O device, the control information is brought out and placed in the channel _____.

After the byte of data has been serviced, the control information is placed back into the special _____.

registers
storage area

The special storage area used by the multiplexor channel is sometimes called "bump" storage because it is physically part of the main storage core array unit. The correct name of this storage area is Multiplexor Storage (abbreviated MPX Storage).

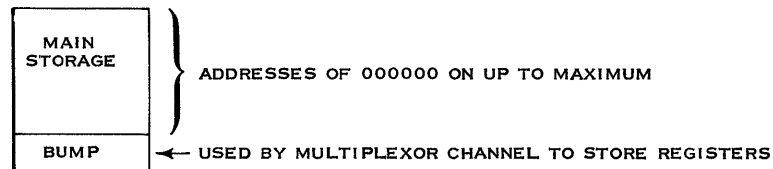

As can be seen above, the "bump" does not use any of the main storage addresses. It is a physical part of the core array used by the main storage unit. However, logically it is separate from it and has separate addressing lines. It is used by the multiplexor channel and is called _____ storage.

MPX

The control information necessary for each I/O device on a multiplexor channel is contained in _____ storage. The control information in MPX storage comes from the original I/O c_____.

MPX commands	Each I/O device has an area in _____ to contain its control information from the original I/O _____.
MPX storage command	MPX storage does not use any of main storage (your own words) _____.
addresses	Operating several I/O devices simultaneously on a multiplexor channel and servicing their data bytes as needed is known as _____ mode.
multiplex	Selector channels can operate with only one I/O device at a time. This mode of operation is called _____.
burst mode	Multiplexor channels can also operate in burst mode if necessary. Burst mode can be forced on the multiplexor channel by the I/O device. This is done if high-speed devices are placed on the multiplexor channel. Multiplexor channels can operate in two modes: _____ and _____.
multiplex mode burst mode	The normal mode of operation for a multiplexor channel is _____. Burst mode can be forced on a multiplexor channel by the _____.
multiplex mode I/O device	We have been discussing burst mode and multiplex mode. Selector channels force burst mode which is the only one in which they can operate. Multiplexor channels can operate in either multiplex mode or in burst mode. Other names for <u>multiplex mode</u> are <u>byte mode</u> and <u>data interleave mode</u> .

SELF-EVALUATION QUESTIONS

1. The operation of a channel with only one I/O device for the entire record is known as _____ mode.
2. _____ channels are designed to operate at high data rates and can operate only in _____ mode.
3. A _____ channel is designed to operate with a number of I/O devices simultaneously.
4. Multiplexor channels can operate in two modes: _____ and _____.
5. The following illustration shows a _____ mode operation.

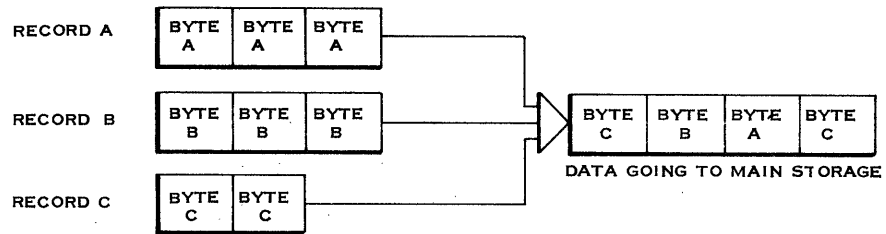

ANSWERS

1. burst
2. selector, burst
3. multiplexor
4. multiplex mode and burst mode
5. multiplex

Device Status Byte

The CSW or channel status word contains eight bytes. In this course, we are only concerned with the device status byte which is in bits 32-39 of the CSW. The device status byte is very important and you should examine it further. Let's take a look at the meaning of the bits.

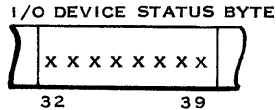

The I/O device status byte represents the following:

- Bit 32 - Attention
- Bit 33 - Status Modifier
- Bit 34 - Control Unit End
- Bit 35 - Busy
- Bit 36 - Channel End
- Bit 37 - Device End
- Bit 38 - Unit Check
- Bit 39 - Unit Exception

Notice two bits which represent an end condition:

- Bit 36 - Channel End
- Bit 37 - Device End

These bits indicate the unit named has "ended" its portion of the operation.

Channel end would indicate that the data transmission of a record over the standard interface has ended.

Device end would indicate that the mechanical operation of the I/O device has ended.

Both channel end and device end may occur together as they would at the end of a tape read or write operation.

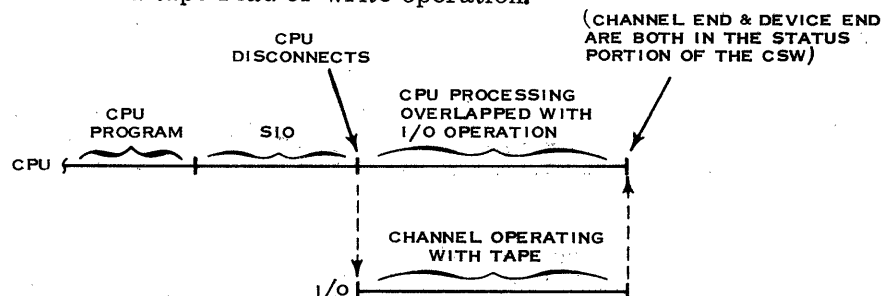

After it has been stored, the CPU program can interrogate the device status byte. If both the channel end and device end bits are present, the CPU program knows that both the I/O device and the channel are available for another operation.

If the channel end bit is present in the CSW, what does this signify to the CPU program?

The channel has ended its portion of the I/O operation and is now available for another operation. It does not indicate that the addressed I/O device is available.

If the device end bit is present in the CSW, what does this signify to the CPU program?

The I/O device (such as a printer) has finished its portion of the operation. This usually consists of a mechanical operation. In the case of a printer, it would mean that the printing cycle has ended.

Can the channel end and device end bits be present together in the CSW?
_____ (Yes/No)

Yes. This would indicate that both the channel and I/O device are finished with the operation. In the case of a unbuffered I/O device, such as a magnetic tape unit, the channel end and device end would usually appear together. In a buffered device such as a 1403 printer, the channel end would appear in the CSW after the buffer has been filled. After the print cycle, the CSW would contain the device end bit.

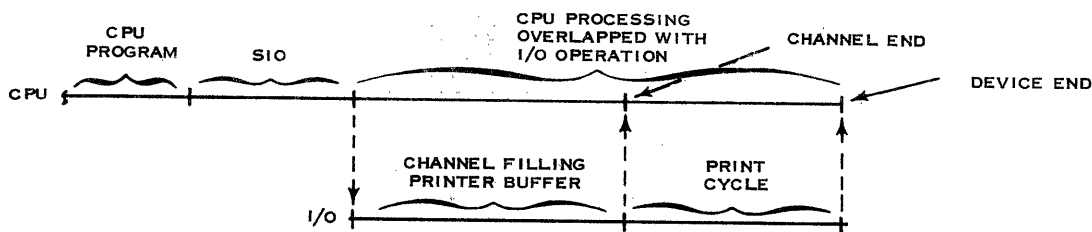

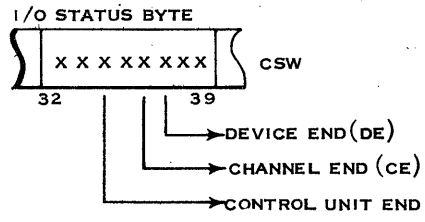

Bit 34 of the CSW represents the c u end bit. This bit is only used for those devices that share a control unit (such as tape units). Even for shared devices, the control unit end does not normally appear in the status byte.

control unit

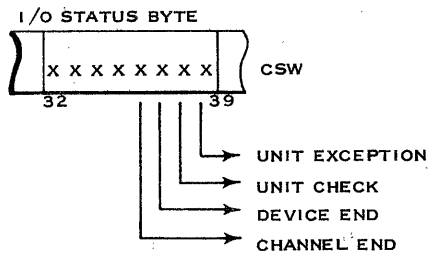

Bits 38 and 39 represent u c and u e respectively.

The unit check bit is used to indicate that an error (such as wrong parity) has been detected by the control unit or I/O device. Channel detected errors would be indicated in the channel's status byte, not in the device's status byte!

The unit exception bit is used to indicate an unusual condition, not an error. Recognizing the end of reel marker during a tape write operation would be an example of a unit exception.

unit check
unit exception

For most operations, the unit check and unit exception bits in the CSW would be set to 0/1.

0 These bits are used to indicate that the I/O device or its control unit has detected an error (unit check) or some unusual condition (unit exception).

Sensing the end of reel marker during a tape write operation is an example of an unusual condition. This condition would be indicated by the bit in the CSW.

unit exception

Reading a tape character with incorrect parity is an example of an error that would be detected by the control unit. This error would be indicated by the _____ bit in the CSW.

unit check

Fill in the labels on the illustration below. Use your Reference Data Card to check your answer.

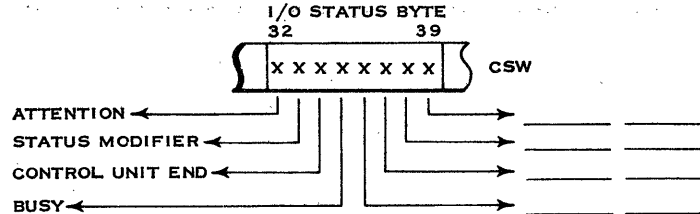

As can be seen above, bit 35 of the channel status word is the bit. That bit is used to indicate that the control unit and/or the I/O device is busy and cannot initiate an I/O operation at the present time. The busy bit is used along with the status modifier bit (CSW bit 33) to indicate the busy states of control unit and I/O device.

busy

Neither of these bits are usually present in the CSW associated with the end of an I/O operation. They are used in the initial "status" byte ("Start I/O" time) to indicate that the operation can't be initiated.

Bit 32 of the CSW is the a bit. This bit has nothing to do with an I/O operation. It is normally the result of operator action at an I/O device. Not all I/O devices have the ability to generate an attention signal.

attention

A status byte is often shown using hex notation. For example, a status byte of 0E indicates that the channel end, device end, and unit check bits are set to 1. The remaining bits are set to 0.

Assume that a tape write operation has been completed. The operation was trouble-free with nothing out of the ordinary. What is the makeup (in hex) of the status byte that could be expected from the tape control unit? _____

0C (in hex). Note that only the channel end and device end bits are present.

Assume that the channel has just finished sending a data record to a printer's buffer. The print cycle has just started. What is the makeup (in hex) of the device status byte in the CSW? _____

08 (in hex). Only Channel End is present. Device End will be presented later at the end of mechanical movement.

SELF-EVALUATION QUESTIONS

1. What bit in the device status byte indicates the end of the data transfer between main storage and the I/O device?
_____ (name of bit)
2. The fact that an I/O device is already doing another operation and cannot perform a new command is indicated by:
 - a. The busy bit presented during Start I/O time.
 - b. The busy bit presented at the end of the channel operation.
3. Which bit in the device status byte would indicate that the end of reel marker had been sensed during a tape write operation? _____ (name of bit)
4. Which bit in the device status byte would indicate that an error had been detected by the I/O device? _____
5. If the device end bit is not presented at the end of a channel operation, will it be presented later on? _____ (Yes/No)
6. Name at least two times that the device status byte is presented to the channel. Give the purpose of each.

ANSWERS

1. channel end
2. a. busy bit at Start I/O time
3. unit exception
4. unit check
5. Yes
6. Device status is presented during Start I/O time to indicate whether or not the operation was started. It is presented again at the end of the operation to indicate whether or not it was error-free.

Introduction to I/O Interface

CONTENTS

	<u>Page</u>	<u>Average Study Time</u>
STANDARD INTERFACE	41	40 Minutes
Self-Evaluation Questions	50	
INTERFACE SEQUENCES	52	45 Minutes
Initial Selection Sequence	53	
Data Handling Sequence	55	
Channel Ending Sequence	56	
Self-Evaluation Questions	58	
INTERFACE OPERATION - SELECTOR CHANNEL	60	75 Minutes
Self-Evaluation Questions	66	
INTERFACE OPERATION - MULTIPLEXOR CHANNEL	68	50 Minutes
Self-Evaluation Questions	73	
CONTROL UNIT BUSY SEQUENCE	75	35 Minutes
Self-Evaluation Questions	77	
INITIAL SELECTION STATUS BYTES	79	35 Minutes
Start I/O - Non Zero Status	79	
Test I/O	81	
Sense Command	81	

Standard Interface

The standard interface (also called the I/O interface) consists of two cables which provide the means of communication between a channel and its I/O units.

There are a total of 34 lines which make up the I/O interface (see Figure 2 facing page 50). These lines are divided into four general areas:

1. The "busses" which are used to transfer bytes of information to and from the channel.
2. The "tag lines" which are used to tell the receiving unit which type of byte (data, status, command, etc.) is on a bus.
3. The "selection controls" which are used to interlock the channel and an I/O device for the purpose of transferring information.
4. The "metering" lines which are used to operate the usage Meters on the I/O units.

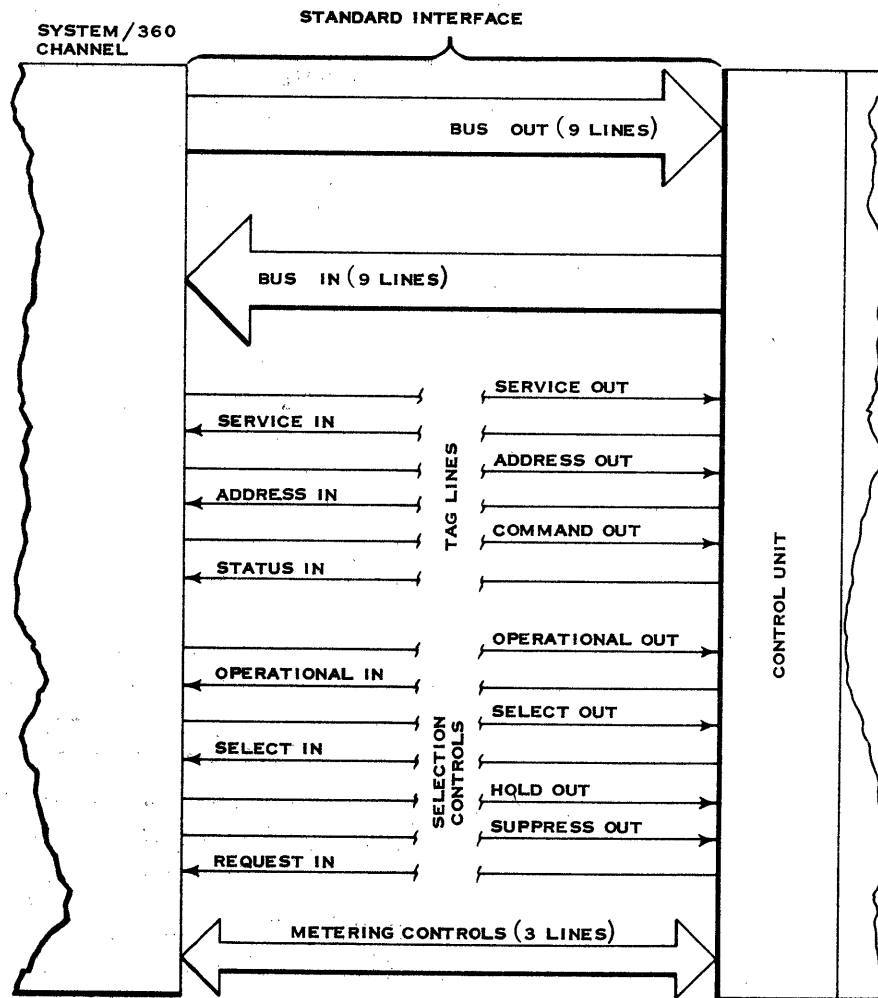

STANDARD INTERFACE LINES

The first thing to note is that all interface lines are identified as in lines or out lines. This is with reference to the channel.

Lines which are activated by the channel are _____ (in/out) lines.

Lines which are activated by the I/O units are _____ (in/out) lines.

out
in

Let's examine the "busses". In this case, the term "bus" refers to a group of nine lines which carry a byte of information.

The nine lines which carry a byte from the channel to the I/O units is called the "Bus Out".

The nine lines which carry a byte from an I/O unit to the channel is called the "_____".

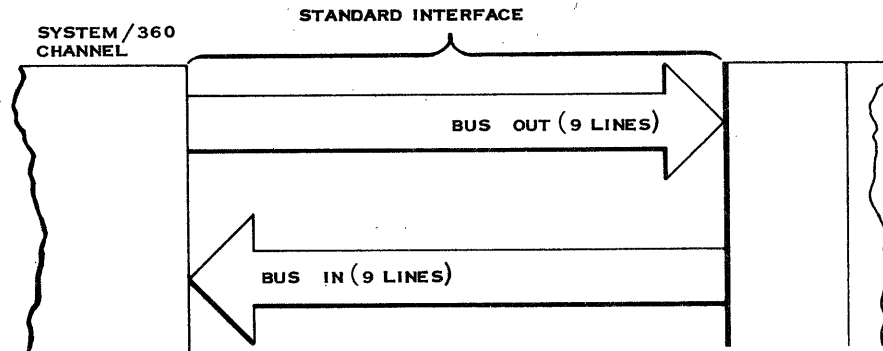

Bus In

On an output operation, the channel would send a data byte to an I/O unit by putting it on the nine _____ lines.

Bus Out

Different types of bytes can be transferred between the channel and the I/O units. For example, the channel can send a command byte to an I/O unit as well as data bytes (output operation). I/O units can send status bytes as well as data bytes (input operation).

For this reason, the six interface lines known as "tag lines" are used to indicate what type of byte is on a bus.

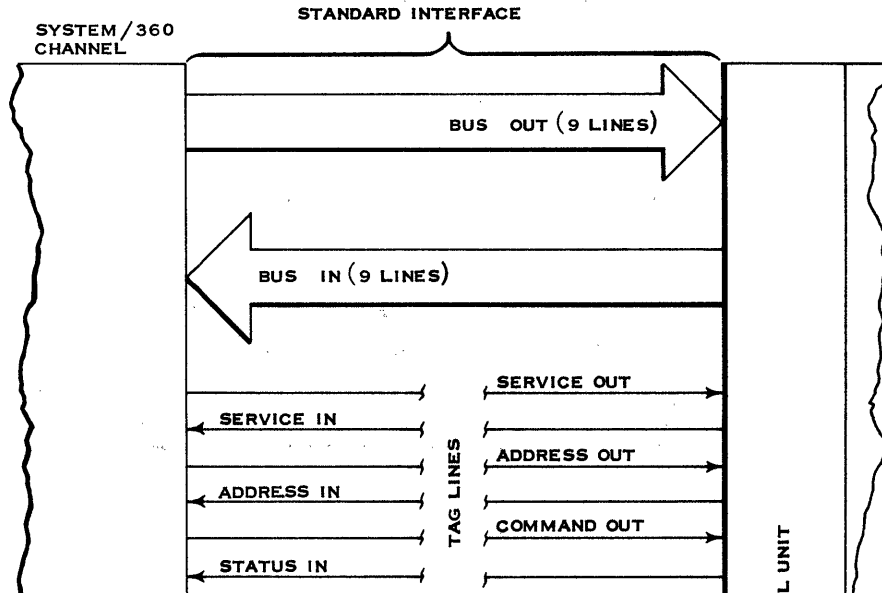

The three "out tag lines" would identify the byte on the Bus Out lines while the three "in tag lines" would identify the byte on the _____ lines.

Bus In

Besides command, data, and status bytes, the "busses" can be used to carry the address of an I/O device. Each I/O device has its own unique 8 bit address.

Shown below are some of the bytes which can be transferred. Write the name of the "tag line" which would be active in each case.

	<u>Byte</u>	<u>Bus</u>	<u>Tag Line</u>
	Data	Out	Service Out
a.	Data	In	Service _____
b.	Status	In	_____
c.	Command	Out	_____
d.	Address	Out	_____

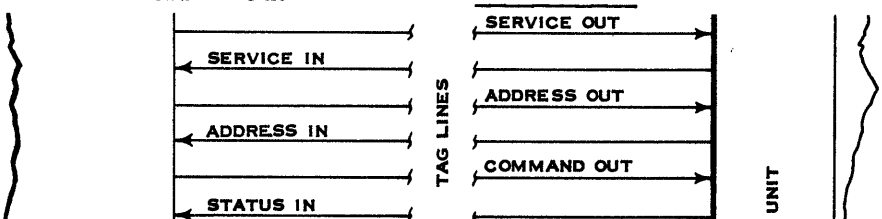

- a. Service In To send a byte to an I/O unit, the channel would put the byte on the
 - b. Status In _____ lines and activate one of the _____ (in/out) tag lines.
 - c. Command Out
 - d. Address Out
-

Bus Out To send a byte to the channel, an I/O unit would put the byte on the
out _____ lines and activate one of the _____ lines.

Bus In The channel can send the following types of bytes to an I/O unit. To do
In Tag this, the byte would be put on the _____ lines.

Indicate which out tag would be activated for each type of byte.

<u>Byte</u>	<u>Tag Line</u>
a. Command byte (from original CCW)	_____
b. Address of I/O unit which the channel wants to select	_____
c. Data byte (on an output operation)	_____

Bus Out An I/O unit can send the following types of bytes to the channel. To
a. Command Out do this the byte would be put on the _____ lines.

- b. Address Out
- c. Service Out

Indicate which tag line would be activated for each type of byte.

<u>Byte</u>	<u>Tag Line</u>
a. Status byte	_____
b. Address of I/O unit which wants to use the interface	_____
c. Data byte (on an input operation)	_____

- Bus In
- a. Status In
- b. Address In
- c. Service In

We have been discussing the use of the tag lines to identify the type of byte being transferred.

The channel has the ability to reject data and status bytes sent by an I/O unit. For this reason, it also uses its tag lines as responses to the I/O unit.

For instance, to send a data byte the I/O unit would put it on the Bus In lines and activate the Service In tag.

- a. if the channel accepts the byte, it will respond with Service Out.
- b. if the channel rejects the byte, it will respond with Command Out.

As a general rule, a response of:

- a. Service Out means the byte was accepted.
- b. Command Out means the byte was rejected.

During the execution of a Start I/O instruction, the I/O unit sends over an initial status byte which indicates if the command was started. To do this the status byte is placed on the _____ lines and the I/O units activate the _____ tag. Since the initial status is usually accepted by the channel, it will respond with its _____ tag.

- Bus In
- Status In
- Service Out

The I/O unit also sends a status byte at the end of the operation. The I/O unit would again put the status byte on the Bus In lines and activate the _____ tag. If for any reason, the channel doesn't want to accept the status byte, it will respond with _____.

- Status In
- Command Out

A channel response of _____ means a byte was accepted.

A channel response of _____ means a byte was rejected.

- Service Out
- Command Out

You have seen that the prime function of the tag lines was to identify the type of byte being transferred over one of the "busses". You have also seen that the channel uses its Service Out and Command Out tags as responses. Respectively, they mean the byte was accepted or rejected.

You will become more familiar with these tag lines as we get deeper into the interface operations. For now, let's take a look at the seven Selection Control lines.

The selection controls are used primarily to interlock the channel and an I/O unit for a period of time. During the execution of a Start I/O instruction, the channel initially selects an I/O unit.

1. If the channel is operating in burst mode, the I/O unit will remain selected for the entire operation until the channel end status byte is received.
2. If the channel is operating in multiplex mode, the I/O unit remains selected only long enough to transfer the required information. When it is necessary to transfer more information, the I/O unit must become re-selected.

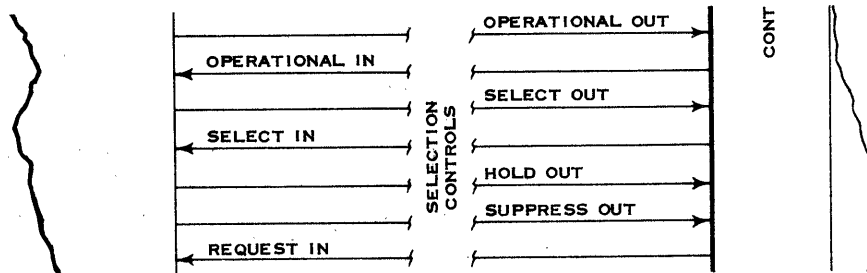

Looking at the Selection Controls, you can see that three lines can be activated by the _____ (I/O unit/channel) and four lines can be activated by the _____.

I/O Unit
Channel

The Select Out line is used to select an I/O unit. When the channel activates Select Out, it can receive one of two responses from an I/O unit.

1. Select In which means that an I/O unit was not selected.
2. Operational In which means that an I/O unit was selected and can now operate on the I/O interface.

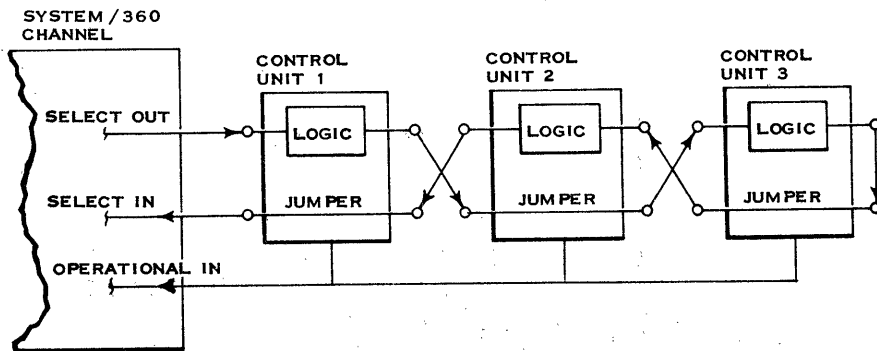

As can be seen in the illustration, the Select Out line proceeds through each I/O unit in series and returns to the channel as the _____ line.

Select In

Note that the Select Out passes through the internal logic of each I/O unit. This means that an I/O unit is able to block the Select Out signal and prevent it from going to the next I/O unit.

If the Select Out signal is blocked by an I/O unit, the Select In line returning to the channel _____ (will/will not) become active.

will not

When an I/O unit becomes selected, it blocks the Select Out signal preventing _____ from becoming active. The I/O unit then activates its Operational In line which tells the channel that an I/O unit was selected.

Select In

Answer these questions.

- a. What line does the channel activate in order to select an I/O unit?

- b. What line returns to the channel if an I/O unit does not respond to selection? _____
- c. What line does an I/O unit activate if it is selected?

- a. Select Out
- b. Select In
- c. Operational In

We have examined three of the Selection Control lines. Another line is Operational Out. This line is normally activated and indicates that the channel is operational.

As long as power is up in the channel and the channel is able to operate, you would expect the _____ line to be active.

Operational Out

Another Selection Control line is Hold Out.

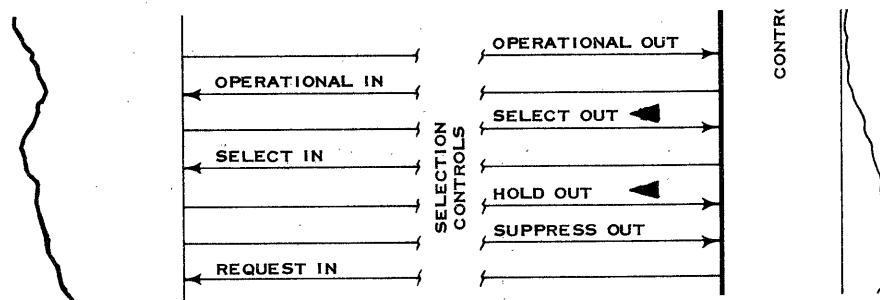

The Hold Out line is activated whenever Select Out is activated. By itself it has no function. When selection is discussed, we usually mention only the Select Out line. However, you should realize that whenever Select Out is active, _____ is also active.

Hold Out

Answer these questions.

- a. A line from the channel that is usually active is the _____ line.
- b. The channel raises Select Out when it wants to select an I/O unit. To become selected, the I/O unit blocks the Select Out line and activates _____.
- c. If no I/O unit responds to (blocks) the Select Out line, it will return to the channel as _____ indicating that an I/O unit was not selected.
- d. Whenever the Channel activates Select Out, it also activates _____.

- a. Operational Out
- b. Operational In
- c. Select In
- d. Hold Out

Earlier we mentioned that an I/O unit was initially selected during the execution of a _____ instruction. The I/O unit remains selected for the entire channel operation if the channel is operating in _____ (burst/multiplexor) mode.

The I/O unit must be re-selected each time it wants to use the interface if the channel is operating in _____ (burst/multiplexor) mode.

Start I/O
burst
multiplexor

The Select Out line is made active during the execution of a Start I/O instruction. This occurs automatically.

However, when a channel is operating in multiplex mode, the I/O unit need to be re-selected each time it wants to transfer a data byte. The channel has no idea of when this need may occur. For this reason, there is a Request In line. By activating Request In, the I/O unit causes the channel to activate its Select Out line.

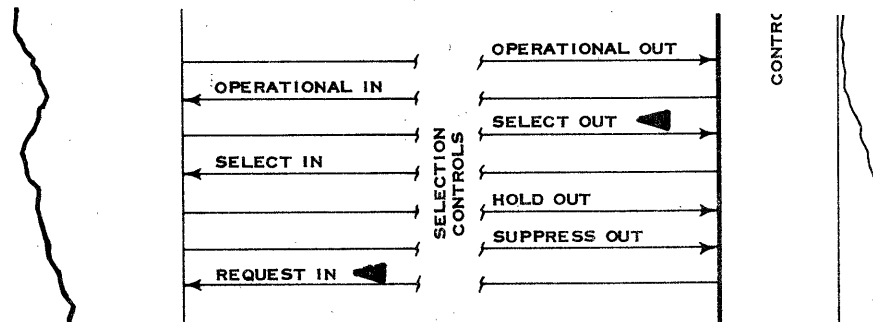

Re-selection begins when an I/O unit activates _____.
 This line in turn causes the channel to activate _____.
 Re-selection is completed when the I/O unit blocks _____
 and activates _____.

Request In
Select Out
Select Out
Operational In

The final Selection Control line to discuss is Suppress Out. Although it has other uses, the prime function of Suppress Out is to prevent I/O units from beginning a re-selection sequence.

For this reason, an I/O unit cannot activate Request In as long as _____ is active from the channel.

Suppress Out

One last point concerning the selection of I/O devices has to do with priority. As long as the channel is operating in burst mode, only one I/O unit is using the interface. When operating in multiplex mode, several I/O units can be alternately using the I/O interface. If two I/O units want to use the interface at the same time, which one should go first? This is priority and is established via internal wiring and interface cabling when the system is installed.

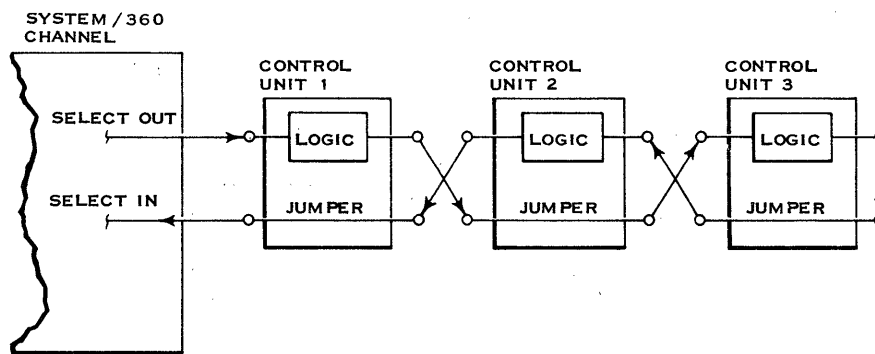

CONTROL UNIT PRIORITY

Refer to the illustration above. Note that Select Out can either be taken through the control unit's internal logic (Control Unit 1), or passed directly to the next control unit (Control Unit 2). The farthest unit from the channel would pass the signal back through the control units. Whichever unit passes Select Out through its internal logic first would have the highest priority. In the illustration, Control Unit 1 has the highest priority and Control Unit 2 has the lowest priority. When the System/360 is installed, priority is established via interface cabling and internal jumper wiring in the I/O control units.

Refer to the illustration above. Suppose that Control Unit 2 activates Request In because it needs a data byte. The channel will then activate its Select Out line. If at this time, Control Unit 3 decided that it needed a data byte also, could it become selected first even though Control Unit 2 activated the Request In line? _____ (Yes/No)

Yes (assuming that Control Unit 3 determined it wanted to use the interface before Select Out reached it.)

In this session, we briefly discussed the I/O interface lines. In the following sessions, we will look at the various interface sequences and how they differ on multiplexor and selector channels.

SELF-EVALUATION QUESTIONS

Refer to Figure 2 facing page 50 to answer these questions.

1. What group of lines are used to transfer a byte from the channel to an I/O unit? _____
2. To identify a byte on the Bus In lines, an _____ (In/Out) tag is activated.
3. For the following types of bytes, indicate which tag line would be activated.

Bytes

Tag Lines

- | | |
|-----------------------------|-------|
| a. Status (I/O to channel) | _____ |
| b. Command (Channel to I/O) | _____ |
| c. Data (I/O to channel) | _____ |
| d. Data (Channel to I/O) | _____ |
| e. Address (I/O to channel) | _____ |
| f. Address (Channel to I/O) | _____ |
-
4. What tag line is activated by the channel whenever it accepts a data or status byte? _____
 5. What tag line is activated by the channel whenever it rejects a data or status byte? _____
 6. Which Selection Control Line from the channel is usually active?

 7. What is the name of the line which proceeds serially through each I/O unit and is used to select an I/O unit? _____
 8. What line does an I/O unit activate when it is selected?

 9. What is the name of the line which returns to the channel if an I/O unit is not selected? _____
 10. What line from the channel is activated along with Select Out?

 11. What line is activated by an I/O unit to begin a re-selection?

 12. What line can be activated by the channel to prevent I/O units from initiating re-selection? _____
 13. Which interface line is involved with priority and how is priority established? _____

	<u>NAME OF LINE</u>	<u>ABBREVIATIONS</u>
BUS OUT (Channel to I/O)	Bus Out Position P	Bus Out P
	Bus Out Position 0	Bus Out 0
	Bus Out Position 1	Bus Out 1
	Bus Out Position 2	Bus Out 2
	Bus Out Position 3	Bus Out 3
	Bus Out Position 4	Bus Out 4
	Bus Out Position 5	Bus Out 5
	Bus Out Position 6	Bus Out 6
	Bus Out Position 7	Bus Out 7
BUS IN (I/O to channel)	Bus In Position P	Bus In P
	Bus In Position 0	Bus In 0
	Bus In Position 1	Bus In 1
	Bus In Position 2	Bus In 2
	Bus In Position 3	Bus In 3
	Bus In Position 4	Bus In 4
	Bus In Position 5	Bus In 5
	Bus In Position 6	Bus In 6
	Bus In Position 7	Bus In 7
TAGS (For identifying the byte on the bus)	Address Out	Adr-Out
	Address In	Adr-In
	Command Out	Cmd-Out
	Status In	Sta-In
	Service In	Srv-In
	Service Out	Srv-Out
SELECTION CONTROLS	Operational Out	Op-Out
	Operational In	Op-In
	Hold Out	Hld-Out
	Select Out	Sel-Out
	Select In	Sel-In
	Suppress Out	Sup-Out
	Request In	Req-In
METERING CONTROLS	Metering Out	Mtr-Out
	Metering In	Mtr-In
	Clock Out	Clk-Out

FIGURE 2 - I/O Interface Lines

ANSWERS

1. Bus Out
2. In
3.
 - a. Status In
 - b. Command Out
 - c. Service In
 - d. Service Out
 - e. Address In
 - f. Address Out
4. Service Out
5. Command Out
6. Operational Out
7. Select Out
8. Operational In
9. Select In
10. Hold Out
11. Request In
12. Suppress Out
13. Priority is established by the sequence in which the Select Out signal passes through the internal logic of the control units. This is done on initial selection via internal wiring and the interface cabling.

Interface Sequences

For any complete input or output operation, there are at least three sequences on the I/O interface. They are:

1. Initial Selection Sequence (as a result of a "start I/O instruction).
2. Data Handling Sequence (to transmit data bytes over the interface).
3. Channel Ending Sequence (to send status byte containing channel end).

If device end wasn't sent during the channel ending sequence, there will be a fourth sequence later on for the status byte with device end.

This illustration shows the I/O Interface sequences for an input operation with a buffered I/O device such as a 2540 Card Reader.

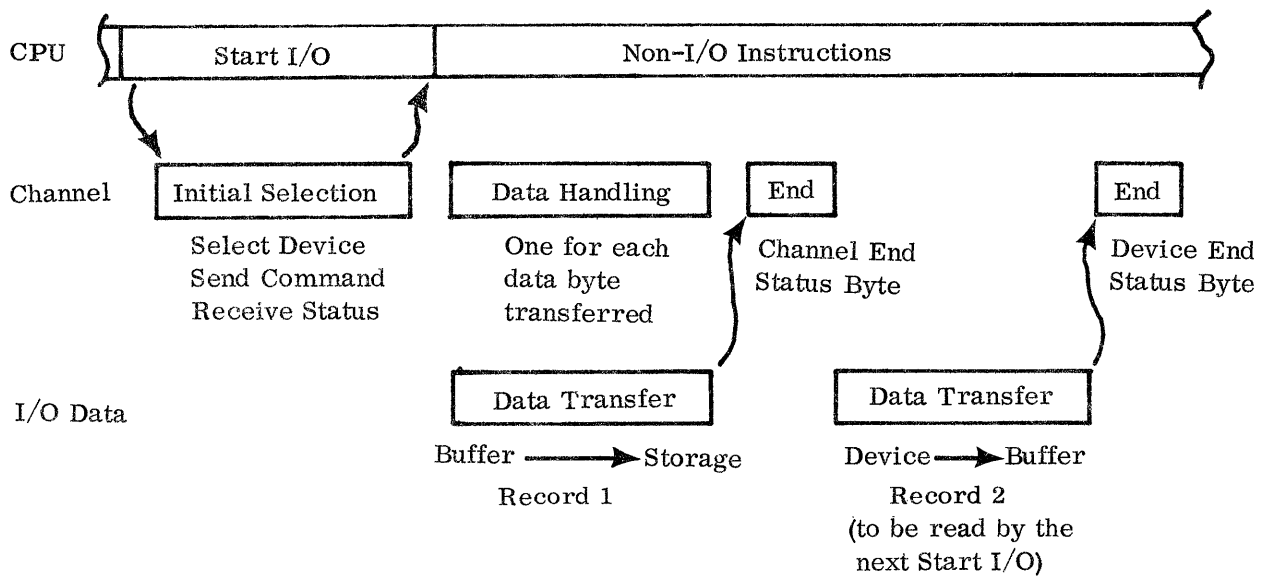

INITIAL SELECTION SEQUENCE

Let's take a look at the three sequences of interface operation starting with initial selection. Refer to Figure 3 facing page 58.

The initial selection sequence will occur during the execution of the "start I/O" instruction. CPU will not disconnect and go on to the next instruction until this sequence is over. Basically, three things happen on the I/O interface during the initial selection sequence:

1. The channel selects the I/O device.
2. The channel sends the command byte to the I/O control unit.
3. The I/O control unit sends a status byte to the channel.

The reason for sending the status byte is to see if the command was initiated. If the status byte contains all zeroes, the command was initiated. CPU disconnects and continues on to the next instruction.

We will now examine the general flow of signals on the I/O interface for an initial selection sequence. Use Figure 3 to answer the questions.

Name two functions accomplished by the initial selection sequence other than selecting the I/O device.

1. _____
 2. _____
-

1. channel sends command byte to I/O device
 2. I/O device sends back its initial status byte
-

How does the channel select an I/O device? _____

it places the device address on the bus out lines and raises address out followed by select out and hold out.

How does a selected I/O device reply to its selection? _____

It activates the Operational In line which tells the channel that an I/O device was selected. In addition, it puts its address on "Bus In" and activates Address In. Note: The address that is placed on bus in is not the same physical address as on bus out. Instead, it comes from the address that is wired into the I/O unit. This allows the channel to verify that the correct I/O unit was selected. However, the two addresses should have the same bit configuration.

How does the channel tell the I/O device what operation to do?

It places the command byte on bus out and signals command out.

What does the I/O device do after it receives the command byte?

The I/O device puts its status byte on bus in and signals status in.

If the operation was started, a status byte of all zero bits would be sent to the channel. The channel would then tell CPU that the operation was started and the status byte would not be put in the CSW. If any of the status bits are set to 1, the status byte would be put in the CSW so the CPU program could examine it.

If we are using a selector channel which operates in burst mode, the channel and I/O units remain tied together after the initial selection sequence. Which interface lines are used to interlock the channel and I/O unit? (Refer to preceding illustration.) _____

DATA HANDLING SEQUENCE

Select out, and hold out from the channel and operational in from the I/O unit.

The data handling sequence during burst mode consists of placing a byte on either bus in (read) or bus out (write). The I/O unit commences a data handling sequence by signalling service in. The sequence is terminated when the channel signals service out. The following flow charts will show the data handling sequence for both input and output operations on a channel that is operating in burst mode.

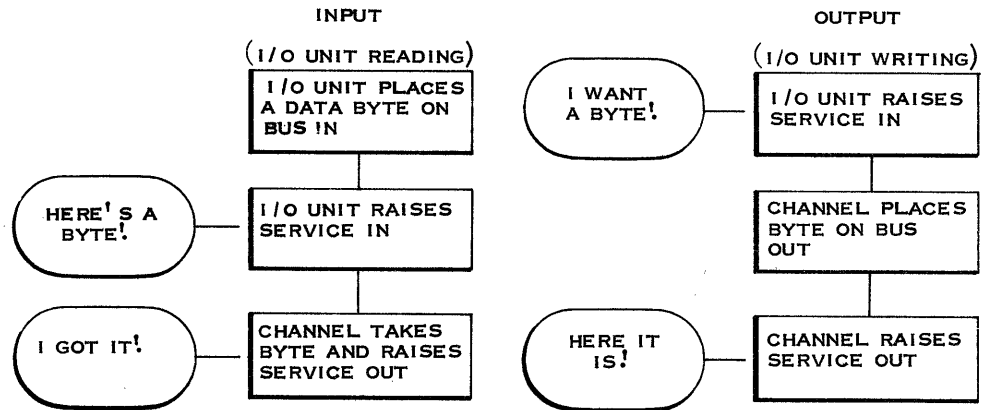

NOTE: For channels operating in multiplex mode, the I/O device would have to be re-selected for each data handling sequence.

On an input operation, how does an I/O device notify the channel that it has a data byte to be stored? _____

By placing the byte on bus in and signalling service in.

How long would the previous data byte remain on bus in? _____

Until the channel says it has the byte by signalling service out.

On an output operation how does the channel know that it should place a data byte on bus out? _____

The I/O unit will signal service in.

How many times will the data handling sequence be repeated during an operation? _____

CHANNEL ENDING SEQUENCE

Once for each data byte

The next I/O interface sequence is the one in which the channel operation is terminated. The prime function of the channel ending sequence is to supply the I/O device's status byte to the channel.

On an output operation, the channel ending sequence is initiated because the count from the CCW was reduced to zero.

On an input operation, there are three possible ending situations:

1. Count field is equal to the number of data bytes in the input record.
2. Count field is greater than the number of data bytes.
3. Count field is less than the number of data bytes.

For our purposes we will take the case of the data bytes being equal to the count field. The following flow charts will show the channel ending sequence for both input and output operations.

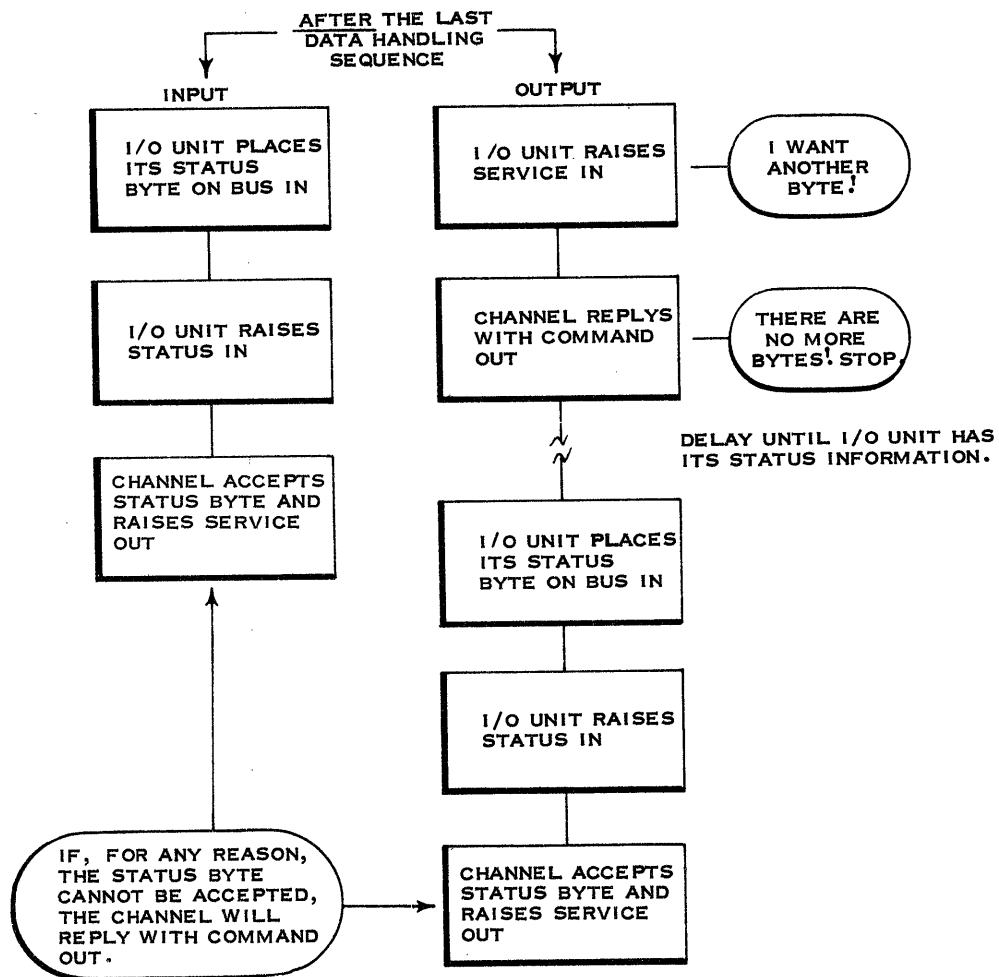

SELF-EVALUATION QUESTIONS

1. Interface lines from the channel to the I/O control units are called _____ (In/Out) lines.
2. What line proceeds serially through the I/O control units and is used to select the I/O unit? _____
3. What line will return to the channel if the addressed I/O device is not attached to the channel? _____
4. During any Start I/O instruction, what is the name of the sequence that occurs on the I/O interface? What three events occur during this sequence:

Sequence Name _____
Events 1. _____
2. _____
3. _____

5. During a data handling sequence for a read operation, what signal tells the channel that a data byte is on the interface lines?
_____ What is usually the channels response?

6. What happens to the status byte sent to the channel during the ending sequence? _____
What is its function? _____
7. What is the function of the status byte sent during the initial selection sequence?

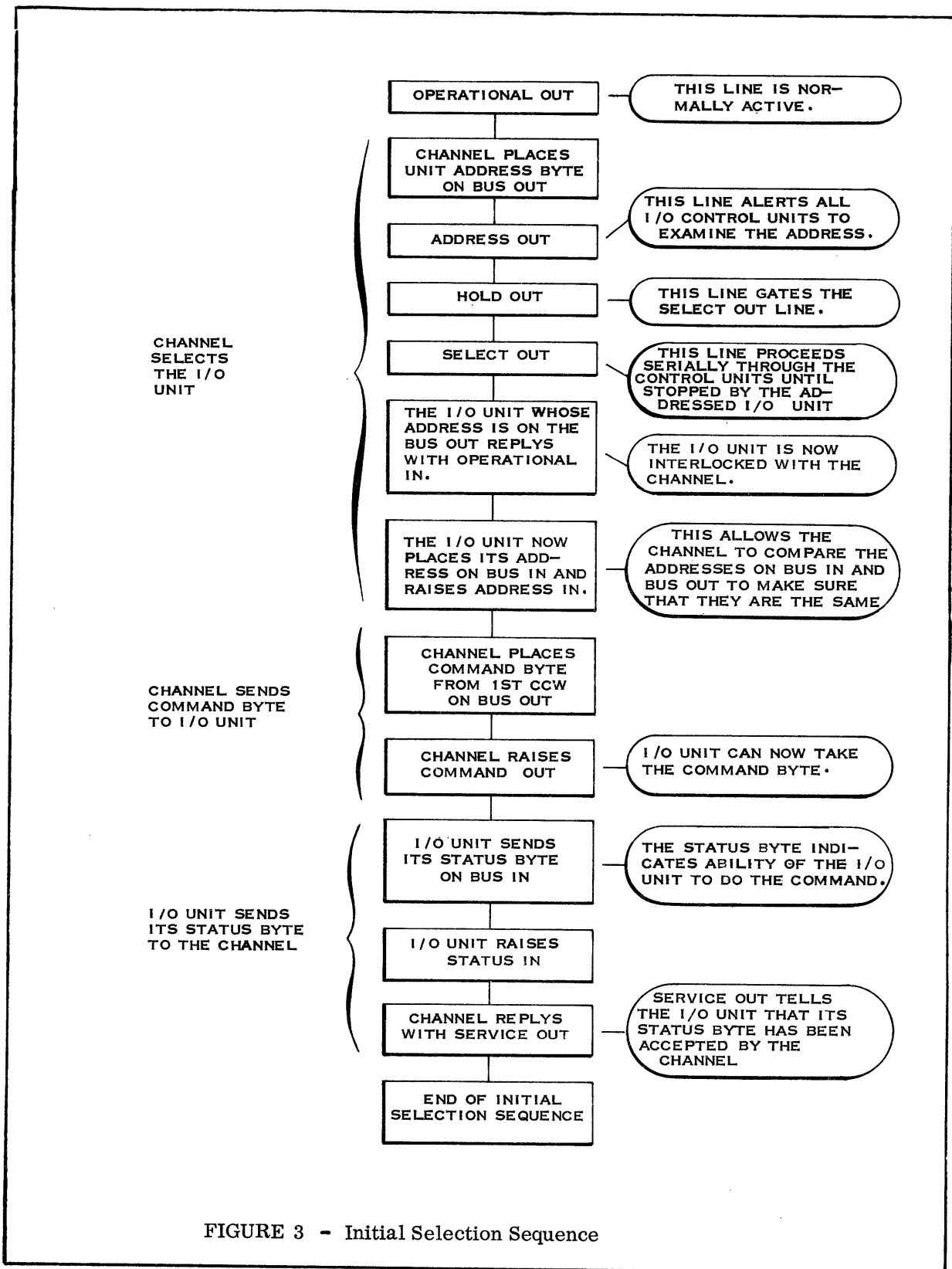

FIGURE 3 - Initial Selection Sequence

ANSWERS

1. out
2. select out
3. select in
4. Initial selection with these functions:
 1. Channel selects I/O device
 2. Channel sends command byte to I/O device
 3. I/O device sends status byte to the channel
5. Service In
Service Out
6. It is placed in the CSW (Channel Status Word) and is used by the CPU program to determine the results of the I/O operation.
7. The status byte sent during initial selection is used to tell the CPU whether or not the operation was started.

out

When the CPU fetches and decodes a "Start I/O" instruction, it signals the appropriate channel to initiate an operation and supplies the channel with the I/O device address. In our example the address is hex 14.

The channel in turn begins the initial selection sequence on the I/O Interface.

The channel places the I/O device address on the _____ lines and raises _____ Out.

Bus Out
Address Out

The placing of the address on the Bus Out lines and raising Address Out is a signal to all control units on the Interface to decode the address.

The control unit at this time sends no response back to the channel. The channel then raises the Hold Out line followed by the _____ line.

Select Out

The Hold Out and Select Out lines always work together. The Hold Out line is only used to condition Select Out and has no other function. From now on, we will only mention Select Out. When we do, you should understand that Hold Out will also come up with Select Out.

When the channel put the device address on Bus-Out and raised Address Out, the control unit did not respond but only decoded the address.

The Select Out line proceeds serially through each control unit on the interface. If the address that was on the Bus-Out lines did not belong to a control unit, the CU would propagate the Select Out line to the next unit.

When Select Out reaches the control unit whose address was on the Bus-Out lines, the control unit does not propagate Select Out. Instead, it responds to the channel by raising _____ (refer to Timing Chart).

Operational In

Notice that the Operational In line and the Select Out line remain up for the duration of the interface sequence. By keeping Select Out up, the channel causes the control unit's Operational In to remain up. The two units are now interlocked and will remain so until Operational In falls. This is to be expected since we are using a Selector Channel which can only operate in _____ (burst/multiplex) mode.

burst

The channel has now selected the I/O unit and the two are interlocked on the Interface. However, before proceeding, the channel demands verification of the I/O device address. The channel wants to be sure that the correct I/O unit is responding.

Each I/O control has addresses for itself and its device wired into the machine. To allow the channel to verify the address, the control unit will now read the wired-in address onto the Bus _____ lines and raise _____ (refer to Timing Chart). In our example, the address placed on the Bus lines should be hex _____.

In
Address In
14

The address placed on the Bus In lines should agree with the one that was originally sent out by the channel. If not, there would have to be some sort of machine malfunction.

After verifying the address, the channel would proceed and send the command byte (hex 02) from the CCW.

To do this the channel would put the _____ byte on the Bus Out lines and raise _____ Out. (Refer to Timing Chart) The control unit would take the command byte and put it in a register.

command
command

The control unit would examine the command to see if it were valid and would determine if the device (tape unit in our example) could do it. It would inform the channel by sending back a status byte for the device.

_____ (Before/After) Command Out falls, the control unit will place the device's _____ byte on the Bus In lines and raise _____.

after
status
status in

Note that Command Out falls before the control unit raised Status In. This is a general interface rule. The control unit will not raise one of its tag lines if a channel tag line is active. Channel tags are Address Out, Command Out, Service Out.

The channel can either accept or reject the status byte. This depends on the operation and the contents of the status byte. In our example, we are saying that everything was okay and the channel will accept our status byte which in this case is all _____. The control unit knows the status byte was accepted because the channel replied with _____ Out. (Refer to Timing Chart)

zeros
Service Out

As a result of the channel's reply, the control unit will drop _____ In. This in turn causes the channel's _____ Out to drop.

Service
Service

The data handling sequence would repeat for the third and fourth tape characters.

At this time, let's refer to the byte count field in our original CCW. This field was originally 0004. The channel will decrease it by 1 as each character comes in from the tape control.

Byte Count

0004	Original
0003	After 1st data handling sequence
0002	After 2nd data handling sequence
0001	After 3rd data handling sequence
0000	After 4th data handling sequence

Let's say that our tape record consisted of more than four characters.

After the fifth character has been read, the tape control will again put the byte on the Bus In lines and raise _____.

Because the byte count field was reduced to zero, the channel will not accept any more data bytes.

To tell the tape control that it will not accept the fifth data byte and not to initiate any more data sequences, the channel responds to Service In with _____ (refer to Timing Chart).

Service In
Command Out

As with the rest of the tag lines, there is a cause and effect relationship between the In and Out tags.

That is, the tape control's fifth Service In does not fall until the channel raises _____. Command Out, in turn, will not fall until _____ drops.

Command Out
Service In

The Timing Chart now shows another delay. In our example, the tape control continues its tape read operation until it reaches the inter-record gap and makes all the final error checks on the record.

After the entire record has been read and checked, the tape control is ready to send the status byte for this operation.

To do this, the tape control places the status bits on the Bus-In lines and raises _____. Since we are expecting a normal error-free tape read operation, the only bits in the status byte should be _____ and _____.

Status In Since we have been working with a selector channel in burst mode, there
Channel End is no reason why the channel can't accept the status byte. As a result,
Device End the channel responds to the tape control with _____ .

Service Out If for any reason the device's status byte cannot be accepted, the
 channel will not respond with Service Out. Instead, it will respond with
 Command Out. Command Out in response to Status In tells the I/O
 control that the status byte was not accepted. The control unit will
 retain the status byte until it can submit at a later time. This is called
 "stacking status".

This is our end sequence. The data bytes have been transferred as well
as the status byte.

The only thing left to do is to break the interlock between the channel
and control unit. Status In during the end sequence causes the channel
to drop _____ , which was preventing the control unit
from dropping _____ .

Select Out Once the channel drops Select Out, Operational In will fall and the
Operational In interlock is broken.

The channel's Service Out caused the tape control's Status In to fall.
In turn, _____ will drop from the channel.

Service Out We have completed one complete channel operation on the I/O Interface.
 We used a selector channel operating in burst mode with a tape unit.

After the end sequence, these two events occur:

1. The tape drives slow to a stop.
 2. The channel retains the end status byte until it can store it in the
CSW (Channel Status Word).
-

Other sequences are shown on Timing Chart 1. We'll return to this
Timing Chart later.

SELF-EVALUATION QUESTIONS

Use Timing Chart 1 to answer these questions.

Answer questions 1-5 True or False.

1. The selector channel forces burst mode because Select Out remains up after the initial selection sequence.
2. Select Out falls after the "channel end" status byte has been received.
3. Operational In cannot fall as long as Select Out remains up.
4. If the end status byte is accepted by the channel, it will signal Service Out.
5. After the byte count in the channel command has been reduced to zero, Service In will get a reply of Service Out.
6. What response will the channel make to Status In to tell the I/O unit to keep its end status byte? _____
7. Can an I/O control raise an In tag line if any of the following channel tags are up? _____ (Yes/No)
 - a. Address Out
 - b. Command Out
 - c. Service Out

ANSWERS

1. True
2. True
3. True
4. True
5. False, Service In will get a reply of Command Out
6. Command Out
7. No

Interface Operation—Multiplexor Channel

Timing Charts 2 and 3 show multiplexor channel operations. Timing Chart 2 shows the multiplexor channel operating in burst mode. Timing Chart 3 shows the multiplexor channel operating in multiplex mode with two devices working concurrently.

Multiplexor channels are designed to operate in multiplex mode but can operate in burst mode. Do you recall how a selector channel forces burst mode? Hint: Consider the Select Out line.

The selector channel keeps the select out line raised. As long as Select Out is up, the I/O control unit cannot drop Operational In.

Now take a look at the Select Out line from a multiplexor channel. Take a look at both Timing Charts 2 and 3. What do you notice about Select Out?

Select Out falls during the initial selection sequence.

Because Select Out drops during the initial selection sequence on a multiplexor channel, Operational In can fall and disconnect the I/O control unit from the channel. This is normal for multiplex mode in order for other I/O units to use the channel.

We did say that the multiplexor channel can operate in burst mode. When this is done, it is usually the I/O unit which forces burst mode and not the channel.

A selector channel forces burst mode by keeping up the Select Out line which prevents Operational In from falling. A control unit can force burst mode on a multiplexor channel by keeping up the _____ line even though Select Out falls (see Timing Chart 2).

Operational In

I/O devices such as tape units would have a difficult time operating in multiplex mode. This is because of their fast data rates and non-stop operation. That is, once a tape read operation is started, there is no way to stop the tape unit between characters. As a result, you would expect that a tape control unit attached to a multiplexor channel _____ (would/would not) force burst mode.

would

To force burst mode, the tape control will keep its _____ line up even though the channel's _____ lines falls during the initial selection sequence.

Operational In
Select Out

I/O units, such as the tape control, usually force burst mode by means of a wired-in switch which allows Operational In to remain up after the initial selection sequence.

Timing Chart 3 shows a multiplexor channel operating in multiplex mode. That is, the I/O unit is not forcing burst mode.

What can you notice about the Operational In line during the initial selection sequence?

It drops after the channel accepts the initial status byte.

When burst mode is forced on a multiplexor channel operation, the data transmission sequences are the same as they were on a selector channel.

That is, on a write operation the I/O control would tell the channel it needed a data byte by raising _____.

The channel would place a data byte on the _____ lines and reply with _____.

Service In
Bus Out
Service Out

With reference to Timing Chart 2, what do you suppose the "byte count" was for this write operation?

0003

When a multiplexor channel is operating in multiplex mode, the I/O unit is disconnected from the channel after the initial selection sequence.

What do you suppose must happen when the I/O unit needs a data handling sequence?

The I/O device must go through a selection sequence for each data byte.

Yes, when operating in multiplex mode, the I/O unit must be re-selected before data handling can begin.

The second sequence on Timing Chart 3 shows a data transmission of a single byte. The sequence begins when the I/O unit desires a data sequence and raises Request In. This causes the channel to send out its Select Out (with Hold Out) signal. As you recall, Select Out proceeds serially through the I/O control units. So it is possible that I/O units with higher priority (earlier position on the Select Out line) can obtain control of the Interface even though it wasn't the one which raised

Request In

It is possible for a unit, other than the one which originally made the request, to lock in on the channel. However, for our example, we'll say that no other unit wants the multiplexor channel at this time.

To review:

- a. The I/O control that wants to use the multiplexor channel raises _____.
- b. The multiplexor channel responds by raising Hold Out and sending out the _____ signal.
- c. The I/O controls pass the Select Out line to the next lower priority control unit until it reaches the unit which raised _____.

- a. Request In
- b. Select Out
- c. Request In

When the Select Out line reaches our requesting unit, it will lock onto the interface by raising _____.

Operational In

In order to handle the data request, the multiplexor channel needs to know what I/O unit is making the request.

The I/O unit places its _____ on the Bus In lines and raises _____ (refer to Timing Chart 3).

address What reponse did the channel make to Address In at this time? (Refer
Address In to Timing Chart) _____

Command Out When Command Out was raised during the initial selection sequence, it
 meant that the command byte for the operation was on the Bus Out lines.

When Command Out is raised during re-selection prior to data
handling, it simply means "proceed". Nothing is placed on the Bus Out
lines other than a P bit to maintain odd parity.

After the I/O address is sent, the channel signals "proceed" by raising
_____. The I/O unit proceeds to the data handling
sequence. If this is an input operation, it puts the byte on Bus In and
raises _____.

Command Out The channel would take the input byte and respond with _____
Service In _____.

Since the data handling sequence is over, the I/O unit would disconnect
from the interface by dropping _____.

Service Out In summary then, the I/O control disconnects from the interface after
Operational In initial selection by dropping Operational In. It has to be re-selected each
 time it wants to begin a data handling sequence. This is true only for
multiplex mode.

Since a control unit can force burst mode by holding up the Operational
In line, it is also possible during multiplex mode to send a short
burst of bytes by temporarily holding up the Operational In line.

This is normal operation for a 2821 control unit (Printer, Reader, Punch
Control) which has buffer storage units. This is shown in the third
sequence on Timing Chart 3. The first two sequences showed initial
selection and a single byte transmission.

The third sequence shows a re-selection of an I/O unit followed by
_____ data byte sequences.

two

How was the I/O unit able to send the second byte without going through another selection?

It keeps its Operational In tag line active.

One last thing to notice about the multi-byte sequence on Timing Chart 3 is the I/O address. Notice that it was Address 24 and different from the preceding sequences which used device address 30. This shows that during multiplex mode, different I/O devices can use the multiplex channel interface for short periods of time.

Let's summarize the information concerning the Command Out tag line.

By definition, an Out tag identifies the information on the Bus Out lines. The prime purpose of the Command Out tag would then be to signal during initial selection that a command byte is being sent to the I/O unit. However, the Command Out line is also activated at other times.

1. During initial selection (in response to Address In) it is used to transmit the Command byte to the I/O unit.
 2. During re-selection (in response to Address In) it is used to tell the I/O unit to proceed into a data handling or end status sequence.
 3. During data handling (in response to Service In) it is used to tell the I/O unit to stop because the byte count has reached zero.
 4. During end status (in response to Status In) it is used to tell the I/O unit that its status byte wasn't accepted and that the I/O unit should "stack" (retain) the status information so it can be presented at a later time.
-

SELF-EVALUATION QUESTIONS

Use Timing Charts 2 & 3 to answer these questions.

Answer True or False for Questions 1-6.

1. SELECT OUT drops during the initial selection sequence for both burst mode and multiplex mode on a multiplexor channel.
2. When operating in multiplex mode, Operational In remains up after the initial selection sequence.
3. I/O control units can force burst mode on a multiplexor channel.
4. During a multiplexing operation it is possible for the I/O unit to transfer two consecutive data bytes after re-selection.
5. Once a unit has gained control of the multiplexor channel interface, it keeps control as long as the Operational In line remains up.
6. Once device address 40 has requested use of the multiplex channel, device 30 can gain control of the interface.
7. Name the "in tag" that causes the multiplex channel to raise its Select Out line.
8. The channel can send a response of Command Out at times other than initial selection. What is on the Bus Out lines at these times? _____

What does Command Out mean

- a. in response to Address In during a re-selection? _____
- b. _____
in response to Status In during an end sequence? _____
- c. _____
in response to Service In during data handling? _____

ANSWERS

1. True
2. False
3. True
4. True; it is possible to transmit two or more data bytes after re-selection by temporarily holding up the Operational In
5. True
6. True; Request In causes the channel to send the Select Out line. If device 30 has a higher priority than device 40, it can obtain control of the interface by not passing on the Select Out line and by raising Operational In.
7. Request In
8. Only a P bit to maintain parity
 - a. proceed with data sequence
 - b. retain the status byte in the control unit and submit it later since the channel is unable to accept it. This is called "stacking".
 - c. no more data bytes will be transferred and the I/O unit should stop its operation.

Control Unit Busy Sequence

In this session we'll look at a special initial selection sequence often referred to as the "short sequence". This is because it consists of a shortened version of the initial selection sequence. It can occur on either a multiplexor or selector channel.

Consider the case of a tape control performing a backspace operation with a tape unit. This involves moving tape in a backward direction from one inter-record gap to the next. A channel is not needed for this operation so it disconnected from the tape control at the end of the initial selection sequence.

Suppose now the CPU fetches another Start I/O instruction and tells the channel to initiate an operation using the same tape control unit. The tape control is busy performing the previous backspace command and can't accept another command. So it has to tell the channel that it is busy before the channel actually sends over the command byte. Therefore, this control unit busy sequence is called the "short sequence".

Examine Timing Chart 1. The three sequences on right are labelled:

- a. Control Command Initiated (this represents the initial selection sequence for the backspace command in our example).
- b. Control-Unit-Busy Selection Response (This represents the initial selection sequence from another Start I/O).
- c. Ending Procedure (This shows the end sequence from the backspace operation presenting device end).

The sequence labelled: "Control-Unit-Busy Selection Response" depicts our "short sequence" and is the one we'll examine.

Remember our conditions. The tape control is busy performing a backspace command and can't accept another one. The channel has been told by the CPU to initiate another command on this tape control unit.

The initial selection sequence begins in the usual manner. The channel places the address of our tape control on the Bus Out lines and raises Address Out.

The channel then proceeds to raise Hold Out and Select Out. Now normally the addressed I/O unit would raise Operational In when it receives Select Out. However, the tape control in our example doesn't want to tie in to the channel. Because it is busy performing a command, it raises Status In now rather than wait for the end of initial selection.

No further response is needed. The channel accepts the status byte and drops its Out lines.

The status byte presented during the "short sequence" will contain a hex 50. This means that these bits are present:

- a. _____ (See page 11 of Reference
- b. _____ Data Card.)

-
- a. Status Modifier The Status Modifier bit along with the busy bit indicates that the control
 - b. busy unit is busy and that a "short sequence" occurred.

When the control unit finishes the current operation, it will submit a status byte as usual. However, it will include a "control unit end" bit to indicate that it had been busy earlier and is now available.

SELF-EVALUATION QUESTIONS

Use Timing Chart 1 to answer these questions.

1. What is another name for the "short sequence"? _____
2. Does the channel place an address on the BUS OUT lines during the "short sequence"? _____ (Yes/No)
3. Does the I/O control unit raise Operational In during the "short sequence"? _____ (Yes/No)
4. When does the I/O control present a status byte and raise Status In during the short sequence? _____

5. Name the two bits present in the status byte presented in a "short sequence".
 - a. _____
 - b. _____

ANSWERS

1. Control Unit Busy
2. Yes
3. No
4. As soon as the Select Out signal reaches the control unit.
5. Busy bit and status modifier bit.

Initial Selection Status Bytes

In the previous sessions we had seen initial selection sequences in which a status byte of all zeros was presented and the operation started. We also saw a special initial selection sequence called the "short sequence" in which the operation wasn't started and the status byte contained the status modifier and busy bits.

Let's take a look at a few more complete initial selection sequences in which the status byte will contain something other than all zero bits.

START I/O - NON-ZERO STATUS

Condition 1: The control unit isn't busy but the device is and the channel wants to start an operation using that device.

Result in Control Unit: The normal initial selection sequence will occur. However, the command will be rejected (since the device is not available at this time) and the status byte will contain just a busy bit (hex 10).

Result in the Channel: The status byte will be stored in the channel status word and CPU will be informed that the operation wasn't started. CPU can examine the CSW to find out why not.

Condition 2: Neither the control unit nor the device is busy doing an operation. However, the device had just completed an operation and the control unit has the device end indication. The channel attempts to start an operation on the device.

Result in the Control Unit: The normal initial selection sequence will occur. However, the command will be rejected (because the control unit has a non-zero status byte) and the status byte will contain the busy bit and the device end bit (hex 14). The busy bit doesn't mean the unit was busy but that the command was rejected due to the device end status byte.

Result in the Channel: The status byte will be stored in the CSW and CPU will be told that the operation wasn't started.

Condition 3: The control unit and the device are both available and there is no status being retained in the control unit from a previous operation. The channel wants to initiate a control command which doesn't require the channel. Assume a Rewind control command addressed to a tape unit.

Result in the Control Unit: A normal selection sequence occurs. The status byte contains channel end (because the channel isn't needed).

Result in the Channel: The status byte will be stored in the CSW. When CPU examines the status byte and doesn't find a busy bit it knows that the operation was started. The channel end bit will tell CPU that another channel operation (on a different device) can be initiated.

On the basis of the preceding three conditions, we should be able to draw a general conclusion. Whenever a command is not initiated for any reason, the _____ bit in the initial status byte will be set to 1.

busy

Given these status bytes presented during initial selection sequences, which one indicates that the command was initiated. (Choose one)

- a. 01010000
 - b. 00001000
 - c. 00010110
-

b (busy bit = 0)

To summarize:

1. The presence of the busy bit indicates that the command was not initiated.
 - a. in the absence of other status bits, the I/O device is busy
 - b. along with the status modifier bit, the I/O control unit is busy
 - c. along with channel end or device end, status is pending from a previous operation.
-

The sequences for the previous three sequences and in the order presented are shown on Timing Chart 2 as the three rightmost sequences labelled:

- a. Command to Busy Device
- b. Command to Device with outstanding Status
- c. Immediate Command Executed

Take a few minutes to look at these sequences and proceed to the next topic.

SELF-EVALUATION QUESTIONS

1. During an initial selection sequence, the channel receives a status byte of hex 10.
 - a. Will the status byte be placed in the CSW _____ (Yes/No)
 - b. Was the operation started? _____ (Yes/No)
 - c. Was the control unit busy performing a command _____ (Yes/No)
 - d. Was the I/O device busy? _____

2. A "short sequence" occurs during the initial selection sequence.
 - a. What two bits will be present in the status byte?

 - b. What do these bits together mean? _____

3. During an initial selection sequence, the channel receives a status byte of hex 11.
 - a. Was the operation started? _____ (Yes/No)
 - b. Assuming that the addressed device is a card reader, what does the status byte of 11 mean? _____

4. Which of the following is false concerning Test I/O?
 - a. During a Test I/O sequence, a command byte of all zeros and a P bit is sent to the control unit.
 - b. Test I/O is a channel command initiated by a Start I/O instruction.
 - c. Test I/O is used to obtain a device's status byte without initiating an operation.

5. What command is used to obtain further information from an I/O unit concerning a unit check indication?

ANSWERS

1. a. Yes
 b. No
 c. No
 d. Yes

2. a. Busy bit and status modifier bit
 b. The control unit is busy; the busy bit without the status modifier bit would indicate that only the device is busy, such as a tape unit rewinding.

3. a. No
 b. The unit exception bit would indicate that the last card had been read into storage on the previous operation. It is now end of file.

4. b. Test I/O is a CPU instruction which requests status information from an I/O device and doesn't require a channel command word.

5. Sense Command

- You should now scan through your I/O Interface SRL Manual. Read it lightly to summarize the points that we discussed in this self-study course. Do not try to memorize the text or even to understand it completely. There are a number of points in the manual that you won't understand now. You'll learn these points later as you progress in your System/360 training on I/O devices and I/O programming. When you finish, contact your Administrator for the Student Quiz.
your Administrator for the Student Quiz.

ALPHABETIC INDEX

	<u>Page</u>
Channel Commands	14
Channel Ending Sequence	55
CONTROL UNIT BUSY SEQUENCE	75
Self-Evaluation Questions	77
Converting Binary to Decimal	6
Data Handling Sequence	55
DEVICE STATUS BYTE	32
Self-Evaluation Questions	36
EBCDIC	7
Hexadecimal Notation	4
INITIAL SELECTION STATUS BYTES	79
Self-Evaluation Questions	82
Initial Selection Sequence	53
INTERFACE OPERATION - MULTIPLEXOR CHANNEL.	68
Self-Evaluation Questions	73
INTERFACE OPERATION - SELECTOR CHANNEL.	60
Self-Evaluation Questions	66
INTERFACE SEQUENCES	52
Self-Evaluation Questions	58
Multiplexor Channels	26
Overview of Channel Operation	17
Parity	8
Sense Command	81
Selector Channels	24
STANDARD INTERFACE	41
Self-Evaluation Questions	50
Start I/O - Non-Zero Status	79
SYSTEM/360 CHANNELS	24
Self-Evaluation Questions	30
SYSTEM/360 CHANNEL ORGANIZATION	13
Self-Evaluation Questions	22
SYSTEM/360 DATA CODING	3
Self-Evaluation Questions	9
Test I/O	81

SR23-3061-3

Courses:

41241

51241

54221



**International Business Machines Corporation
Field Engineering Division
360 Hamilton Avenue, White Plains, N.Y. 10601**

**IBM World Trade Americas/Far East Corporation
Town of Mount Pleasant, Route 9, North Tarrytown, N.Y., U.S.A. 10591**

**IBM World Trade Europe/Middle East/Africa Corporation
360 Hamilton Avenue, White Plains, N.Y., U.S.A. 10601**

On an output operation, how does the channel tell the I/O unit to stop? _____

After the last data byte has been transferred, the count from the CCW is reduced to zero. The next time the I/O unit says service in, the channel will tell it to stop by replying with command out.

On an input operation, how does the I/O unit notify the channel that it has finished transmitting data bytes? _____

The I/O unit comes in with its status byte and signals status in.

What response will the channel make if it takes the status byte?

Service Out

What response will the channel make if it does not take the status byte and wants the I/O unit to "stack" (retain) its status?

Command Out

If device end is not in the channel ending status byte, the I/O unit will send another status byte later on that will contain device end.

The interlock between the channel and the I/O unit is dropped after the channel ending sequence. To submit device end at a later time, the I/O unit will have to be re-selected.